

CD-2u SD/CD RECORDER

SD-2u SD RECORDER

Owner's Manual



This owner's manual applies to both the CD-2u and the SD-2u.

A **CD-2u only** icon or **SD-2u only** icon will be used to mark explanations that pertain only to a specific model.

Before using this unit, carefully read the sections entitled "USING THE UNIT SAFELY" and "IMPORTANT NOTES" (Page 8–11; Page 12–13). These sections provide important information concerning the proper operation of the unit. Additionally, in order to feel assured that you have gained a good grasp of every feature provided by your new unit, read Owner's Manual in its entirety. This manual should be saved and kept on hand as a convenient reference.

Copyright © 2013 ROLAND CORPORATION

All rights reserved. No part of this publication may be reproduced in any form without the written permission of ROLAND CORPORATION.

For the U.K.

IMPORTANT: THE WIRES IN THIS MAINS LEAD ARE COLOURED IN ACCORDANCE WITH THE FOLLOWING CODE.

BLUE: NEUTRAL
BROWN: LIVE

As the colours of the wires in the mains lead of this apparatus may not correspond with the coloured markings identifying the terminals in your plug, proceed as follows:

The wire which is coloured BLUE must be connected to the terminal which is marked with the letter N or coloured BLACK.

The wire which is coloured BROWN must be connected to the terminal which is marked with the letter L or coloured RED.

Under no circumstances must either of the above wires be connected to the earth terminal of a three pin plug.

Check the Included Items

The CD-2u/SD-2u includes the following items. Please take a moment to confirm that all of these items have been included with the CD-2u/SD-2u. If you find that any item is missing, contact the nearest authorized Roland distributor in your country.

- CD-2u/SD-2u (The illustration depicts the CD-2u)



- Owner's Manual



- Quick Start

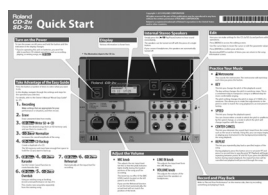

- Remote controller



- AC Adaptor/Power cord

* The shape of the power cord's plug varies depending on the country.

- CD-R disc **CD-2u only**

- SD memory card

* The SD memory card contains demo songs (Page 28).

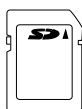

- SD memory card Protector



Table of Contents

Checking and Preparations

USING THE UNIT SAFELY	8
IMPORTANT NOTES.....	12
Panel Descriptions	14
Recordable Media and Functionality.....	20
Turning the Power On and Off.....	22
Using the Dedicated AC Adaptor	22
Using Batteries.....	24
Preparing an SD Memory Card	26
Preparing a CD CD-2U only	29
Preparing the Remote Control	31
Replacing the Remote Control's Battery.....	31
Using the Remote Control	32
Menu Operations	33
About Easy Guide.....	37
Setting Items in Easy Guide.....	38

Recording

Recording Acoustic Instruments or Vocals.....	41
Recording with the Internal Mics	41
Connecting the External Mics for Recording.....	45
Recording an Electronic Instrument.....	50
Recording a Cassette or Digital Audio Player	52
Recording Karaoke.....	54
Layering your Performance onto an SD Memory Card Song and Recording It.....	59
Convenient Functions for Recording.....	62
Automatically Starting Recording When Audio is Detected	62
Assigning Song Numbers While Recording (Marker).....	64
Preventing Loud Sounds from Distorting (Limiter).....	67
Inserting a Count Before Recording Begins (Count-in).....	68

Listening

Listening to a CD/Listening to an SD Memory Card	70
Convenient Functions for Playback	72
Adjusting the Tone (Bass/Treble)	72
Adding Reverberation (Reverb).....	73
Muting the Sound of the Speakers.....	74
Exchanging the Left and Right Audio Channels for Playback.....	74













Convenient Functions for practicing

Changing the Key of the Playback	75
Making Fine Adjustments to the Playback Pitch (Pitch).....	76
Slowing Down or Speeding Up Playback	77
Enjoying Simple Karaoke (Center Cancel)	78
Repeatedly Playing Tracks (1 Track/All Repeat)	79
Repeatedly playing a portion of the song (A/B Repeat)	80
Sounding the Metronome.....	81
Tuning Your Instrument (Tuner Function).....	83
Changing the Tuner's Reference Pitch	84
Listening to a Guide Tone While Tuning	85







Deleting	Deleting Songs from an SD Memory Card 86
	Deleting Songs Individually 86
	Erasing All Tracks 87
	Deleting an Unwanted Region at the Beginning of the Song (Trim In)..... 88
	Deleting an Unwanted Region at the End of the Song (Trim Out)..... 90
Creating a CD	Erasing Tracks from a CD-RW Disc CD-2u only 92
	Deleting One Song at a Time (Only the Last Song)..... 92
	Erasing All Tracks 93
	Removing Finalization..... 94
	Selecting Songs from an SD Memory Card to Create a CD CD-2u only 95
Editing an SD memory card	Making a music CD from a song recorded on a device such as the Roland R-05/R-09 series CD-2u only 98
	Making a CD-R/RW Disc for Playback on Another CD Player (Finalize) CD-2u only 99
	Creating a Duplicate of an Original Music CD (Backup) CD-2u only 100
	Moving a Song 103
	Dividing a Track 104
Viewing Information and Screen Display	Joining Songs 106
	Maximizing the Volume of a Song 107
	Creating a Copy of a Song in a New Key 108
	Creating a Copy of a Song in a New Pitch 109
	Creating a Copy of a Song at a New Playback Speed..... 110
Advanced Uses	Creating a Copy of a Song with the Center Cancelled 111
	Viewing the Remaining Recording/Playback Time 112
	Viewing Information about an SD Memory Card 113
	Viewing Information about a CD-R/RW Disc CD-2u only 114
	Adjusting the Readability of the Screen (Contrast)..... 115
Appendices	Automatically Dimming the Screen (Backlight Timer) 116
	Changing the Screen Display Language 117
	Returning the Menu Settings to their Factory-Set Condition (Factory Reset) 118
	Formatting an SD Memory Card 119
	Adjusting the Left/Right Volume Balance of the Internal Mics..... 120
Appendices	Reversing the Stereo Field of the Internal Mics..... 121
	Connecting External Speakers..... 123
	Troubleshooting 125
	Messages 132
	Specifications 134
	Index 135
	Information 140

List of Common Tasks

Recording

- Automatically start new songs at silent spaces when recording from a cassette or MD  [Page 66](#) (Auto Marker)
- Automatically start recording when a performance begins  [Page 62](#)
(Automatically Recording)
- Let the CD-2u/SD-2u adjust the input level  [Page 44](#) (Auto Level)
 [Page 44](#) (Rehearsal)
- Sound a count before recording begins  [Page 68](#) (Count-in)
- Record your vocal along with karaoke backing  [Page 54](#) (Overdubbing)
- Overdub-record  [Page 59](#) (Overdubbing)
- Make a well-balanced recording of an ensemble  [Page 120](#)
(Internal Mics Balance)
- Record without distortion  [Page 67](#) (Limiter)
- Return a CD-RW disc to a recordable state  [Page 94](#) (Unfinalize) **CD-2u only**
- Check how much recording time is left  [Page 112](#) (Remaining Time)
- Check the capacity of the currently inserted SD memory card  [Page 113](#) (Card Information)
- Check the capacity of the currently inserted CD-R/RW disc  [Page 114](#) (Disc Information) **CD-2u only**

Deleting

- Delete a song from an SD memory card  [Page 86](#) (One Track)
 [Page 87](#) (All Tracks)
- Delete a song from a CD-RW disc  [Page 92](#) (Last Track)
 [Page 93](#) (All Tracks) **CD-2u only**
- Delete unwanted silence before or after a song  [Page 88](#) (Trim In)
 [Page 90](#) (Trim Out)
- Protect an important song from accidental erasure  [Page 26](#) (Protect Switch)

Listening

- Listen to the same phrase repeatedly 👉 Page 80 (A-B Repeat)

- Listen to a song repeatedly 👉 Page 79 (Repeat)

- Listen to a song at different speeds 👉 Page 77 (Speed)

- Use a commercial music CD for karaoke 👉 Page 78 (Center Cancel)

- Resume playback where you last stopped 👉 Page 71 (Resume)

- Apply reverb 👉 Page 73 (Reverb)

- Boost a softly recorded song to maximum volume 👉 Page 107 (Normalize)

Creating a CD

- Make a duplicate of an original music CD you created 👉 Page 100 (Backup) **CD-2u only**

- Complete a CD 👉 Page 99 (Finalize) **CD-2u only**

Other

- Use the CD-2u/SD-2u where there's no AC power 👉 Page 24 (Batteries)

- Extend battery life 👉 Page 116 (Backlight Timer)

- Connect speakers to listen 👉 Page 123 (External Speakers)

- Restore the CD-2u/SD-2u to its factory-set condition 👉 Page 118 (Factory Reset)



- Change the metronome's sound or tempo 👉 Page 76 (Metronome)



- Tune your instrument 👉 Page 83 (Tuner)

- Use the remote controller 👉 Page 31 (Remote Control)







USING THE UNIT SAFELY

INSTRUCTIONS FOR THE PREVENTION OF FIRE, ELECTRIC SHOCK, OR INJURY TO PERSONS

About  **WARNING** and  **CAUTION** Notices

 WARNING	Used for instructions intended to alert the user to the risk of death or severe injury should the unit be used improperly.
 CAUTION	Used for instructions intended to alert the user to the risk of injury or material damage should the unit be used improperly. * Material damage refers to damage or other adverse effects caused with respect to the home and all its furnishings, as well to domestic animals or pets.

About the Symbols

	The  symbol alerts the user to important instructions or warnings. The specific meaning of the symbol is determined by the design contained within the triangle. In the case of the symbol at left, it is used for general cautions, warnings, or alerts to danger.
	The  symbol alerts the user to items that must never be carried out (are forbidden). The specific thing that must not be done is indicated by the design contained within the circle. In the case of the symbol at left, it means that the unit must never be disassembled.
	The  symbol alerts the user to things that must be carried out. The specific thing that must be done is indicated by the design contained within the circle. In the case of the symbol at left, it means that the power-cord plug must be unplugged from the outlet.

ALWAYS OBSERVE THE FOLLOWING

WARNING

To completely turn off power to the unit, pull out the plug from the outlet

Even with the power switch turned off, this unit is not completely separated from its main source of power. When the power needs to be completely turned off, turn off the power switch on the unit, then pull out the plug from the outlet. For this reason, the outlet into which you choose to connect the power cord's plug should be one that is within easy reach and readily accessible.



Concerning the Auto Off function

The power to this unit will be turned off automatically after a predetermined amount of time has passed since it was last used for playing music, or its buttons or controls were operated (Auto Off function). If you do not want the power to be turned off automatically, disengage the Auto Off function (Page 23).



Do not disassemble or modify by yourself

Do not open (or modify in any way) the unit or its AC adaptor.



Do not repair or replace parts by yourself

Do not attempt to repair the unit, or replace parts within it (except when this manual provides specific instructions directing you to do so). Refer all servicing to your retailer, the nearest Roland Service Center, or an authorized Roland distributor, as listed on the "Information" page.



WARNING

Do not use or store in the following types of locations

Subject to temperature extremes (e.g., direct sunlight in an enclosed vehicle, near a heating duct, on top of heat-generating equipment); or are

- Damp (e.g., baths, washrooms, on wet floors); or are
- Exposed to steam or smoke; or are
- Subject to salt exposure; or are
- Humid; or are
- Exposed to rain; or are
- Dusty or sandy; or are
- Subject to high levels of vibration and shakiness.



Use only stand that is recommended

This unit should be used only with a stand that is recommended by Roland.



Do not place in a location that is unstable

When using the unit with a stand recommended by Roland, the rack or stand must be carefully placed so it is level and sure to remain stable. If not using a rack or stand, you still need to make sure that any location you choose for placing the unit provides a level surface that will properly support the unit, and keep it from wobbling.



Precautions regarding placement of this unit on a stand

Be sure to follow the instructions in the Owner's Manual carefully when placing this unit on a stand (Page 19).



If it is not set up properly, you risk creating an unstable situation which could lead to the unit falling or the stand toppling, and may result in injury.

⚠ WARNING

Use only the supplied AC adaptor and the correct voltage

Be sure to use only the AC adaptor supplied with the unit. Also, make sure the line voltage at the installation matches the input voltage specified on the AC adaptor's body. Other AC adaptors may use a different polarity, or be designed for a different voltage, so their use could result in damage, malfunction, or electric shock. 

Use only the supplied power cord

Use only the attached power-supply cord. Also, the supplied power cord must not be used with any other device. 



Do not bend the power cord or place heavy objects on it

Do not excessively twist or bend the power cord, nor place heavy objects on it. Doing so can damage the cord, producing severed elements and short circuits. Damaged cords are fire and shock hazards! 

Avoid extended use at high volume

This unit, either alone or in combination with an amplifier and headphones or speakers, may be capable of producing sound levels that could cause permanent hearing loss. Do not operate for a long period of time at a high volume level, or at a level that is uncomfortable. If you experience any hearing loss or ringing in the ears, you should immediately stop using the unit, and consult an audiologist. 

Don't allow foreign objects or liquids to enter unit; never place containers with liquid on unit

Do not place containers containing liquid (e.g., flower vases) on this product. Never allow foreign objects (e.g., flammable objects, coins, wires) or liquids (e.g., water or juice) to enter this product. Doing so may cause short circuits, faulty operation, or other malfunctions. 



Turn off the unit if an abnormality or malfunction occurs

Immediately turn the unit off, remove the AC adaptor from the outlet, and request servicing by your retailer, the nearest Roland Service Center, or an authorized Roland distributor, as listed on the "Information" page when: 

- The AC adaptor, the power-supply cord, or the plug has been damaged; or
- If smoke or unusual odor occurs; or
- Objects have fallen into, or liquid has been spilled onto the unit; or
- The unit has been exposed to rain (or otherwise has become wet); or
- The unit does not appear to operate normally or exhibits a marked change in performance.

⚠ WARNING

Adults must provide supervision in places where children are present

When using the unit in locations where children are present, be careful so no mishandling of the unit can take place. An adult should always be on hand to provide supervision and guidance. 

Do not drop or subject to strong impact

Protect the unit from strong impact. (Do not drop it!) 





Do not share an outlet with an unreasonable number of other devices

Do not force the unit's power-supply cord to share an outlet with an unreasonable number of other devices. Be especially careful when using extension cords—the total power used by all devices you have connected to the extension cord's outlet must never exceed the power rating (watts/amperes) for the extension cord. Excessive loads can cause the insulation on the cord to heat up and eventually melt through. 



Do not use overseas

Before using the unit in overseas, consult with your retailer, the nearest Roland Service Center, or an authorized Roland distributor, as listed on the "Information" page. 

Handle batteries carefully

- Batteries must never be recharged, heated, taken apart, or thrown into fire or water. 
- Never expose batteries to excessive heat such as sunshine, fire or the like. 
- Incorrect handling of batteries or rechargeable batteries, can cause leakage, overheating, fire, or explosion. Before use, you must read and strictly observe all of the precautions that accompany the batteries, rechargeable batteries, or battery charger. 

- When using rechargeable batteries and a charger, use only the combination of rechargeable batteries and charger specified by the battery manufacturer.

Handle lithium batteries carefully

- Lithium batteries must never be recharged, heated, taken apart, or thrown into a fire or water. 
- Keep lithium batteries out of reach of small children. If a child has accidentally swallowed a battery, see a doctor immediately. 
- Never expose lithium batteries to excessive heat such as sunshine, fire or the like. 

⚠ CAUTION

Place in a well ventilated location

The unit and the AC adaptor should be located so their location or position does not interfere with their proper ventilation. 

Use only the specified stand

This unit is designed to be used in combination with specific stand (SS-PC1) manufactured by Roland. If used in combination with other stands, you risk sustaining injuries as the result of this product dropping down or toppling over due to a lack of stability. 

Evaluate safety issues before using stands

Even if you observe the cautions given in the owner's manual, certain types of handling may allow this product to fall from the stand, or cause the stand to overturn. Please be mindful of any safety issues before using this product. 

When disconnecting an AC adaptor, grasp it by the plug

To prevent conductor damage, always grasp the AC adaptor by its plug when disconnecting it from this unit or from a power outlet. 

Periodically clean the AC adaptor's plug

At regular intervals, you should unplug the AC adaptor and clean it by using a dry cloth to wipe all dust and other accumulations away from its prongs. Also, disconnect the power plug from the power outlet whenever the unit is to remain unused for an extended period of time. Any accumulation of dust between the power plug and the power outlet can result in poor insulation and lead to fire. 

Manage cables for safety

Try to prevent cords and cables from becoming entangled. Also, all cords and cables should be placed so they are out of the reach of children. 

Avoid climbing on top of the unit, or placing heavy objects on it

Never climb on top of, nor place heavy objects on the unit. 

Do not connect or disconnect the AC adaptor with wet hands

Never handle the AC adaptor or its plugs with wet hands when plugging into, or unplugging from, an outlet or this unit. 

Disconnect everything before moving the unit

Before moving the unit, disconnect the AC adaptor and all cords coming from external devices. 

⚠ CAUTION

Unplug the AC adaptor from the outlet before cleaning



Before cleaning the unit, turn it off and unplug the AC adaptor from the outlet (Page 22). 

If there is a possibility of lightning strike, disconnect the AC adaptor from the outlet



Whenever you suspect the possibility of lightning in your area, disconnect the AC adaptor from the outlet. 

Handle batteries carefully

If used improperly, batteries may explode or leak and cause damage or injury. In the interest of safety, please read and observe the following precautions (Page 24). 

- Carefully follow the installation instructions for batteries, and make sure you observe the correct polarity. 
- Avoid using new batteries together with used ones. In addition, avoid mixing different types of batteries. 
- Remove the batteries whenever the unit is to remain unused for an extended period of time.
- Never keep batteries together with metallic objects such as ballpoint pens, necklaces, hairpins, etc.
- Used batteries must be disposed of in compliance with whatever regulations for their safe disposal that may be observed in the region in which you live.

Handle lithium batteries carefully

- Use only the specified type (model no. CR2025) of lithium batteries (Page 31). Be sure to insert it as directed (to ensure correct polarity). 
- Used lithium batteries must be disposed of in compliance with whatever regulations for their safe disposal that may be observed in the region in which you live. 

Take care so as not to get fingers pinched CD-2U only

When handling the following moving parts, take care so as not to get fingers etc. pinched. Whenever a child uses the unit, an adult should be on hand to provide supervision and guidance. 

- CD-R/RW drive (Page 29)

Keep small items out of the reach of children

To prevent accidental ingestion of the parts listed below, always keep them out of the reach of small children. 

- Included Parts
 - SD memory card (Page 26)
 - SD memory card protector (Page 28)
- Removable Parts
 - screws (Page 27)

 **CAUTION**
Handle the ground terminal carefully

If you remove the screw from the ground terminal, be sure to replace it; don't leave it lying around where it could accidentally be swallowed by small children. When refastening the screw, make that it is firmly fastened, so it won't come loose.

**Precautions concerning use of phantom power supply**

Always turn the phantom power off when connecting any device other than condenser microphones that require phantom power. You risk causing damage if you mistakenly supply phantom power to dynamic microphones, audio playback devices, or other devices that don't require such power. Be sure to check the specifications of any microphone you intend to use by referring to the manual that came with it.



(This instrument's phantom power: 48 V DC, 8 mA Max)

Handle leaking batteries carefully

- If fluid has leaked from a battery, make sure not to touch it with your bare hands.
- If any of the leaking fluid gets into your eyes, the loss of vision may result. Do not rub your eyes; use clean water to flush them thoroughly. Then, promptly see a doctor.
- Burning of the skin or dermatitis may result if fluid has gotten onto your skin or clothing. Use clean water to flush affected areas thoroughly; then, promptly see a doctor.
- Using a soft cloth, carefully wipe any remaining fluid from the inside of the battery compartment. Then, install new batteries.



IMPORTANT NOTES

Power Supply

- Do not connect this unit to same electrical outlet that is being used by an electrical appliance that is controlled by an inverter or a motor (such as a refrigerator, washing machine, microwave oven, or air conditioner). Depending on the way in which the electrical appliance is used, power supply noise may cause this unit to malfunction or may produce audible noise. If it is not practical to use a separate electrical outlet, connect a power supply noise filter between this unit and the electrical outlet.
- The AC adaptor will begin to generate heat after long hours of consecutive use. This is normal, and is not a cause for concern.
- The use of an AC adaptor is recommended as the unit's power consumption is relatively high. Should you prefer to use batteries, please use the alkaline batteries or rechargeable Ni-MH batteries.
- To prevent malfunction and equipment failure, always make sure to turn off the power on all your equipment before you make any connections.

Power Supply: Use of Batteries

- When installing or replacing batteries, always turn this unit off and disconnect any other devices you may have connected. This way, you can prevent malfunction and damage.
- A battery was installed in the remote controller before it left the factory. The life of this battery may be limited, however, since its primary purpose was to enable testing.
- If the batteries run extremely low, the sound may distort / interruptions in the sound may occur at high volume levels, but this does not indicate a malfunction. If this occurs, please replace the batteries / use the included AC adaptor.
- If operating this unit on batteries, please use alkaline batteries or rechargeable Ni-MH batteries.
- If operating this unit on batteries, please disconnect the AC adaptor from this unit.
- Even if batteries are installed, the unit will turn off if you connect or disconnect the power cord from the AC outlet while the unit is turned on, or if you connect or disconnect the AC adaptor from the unit. When this occurs, unsaved data may be lost. You must turn off the power before you connect or disconnect the power cord or AC adaptor.

Placement

- Using the unit near power amplifiers (or other equipment containing large power transformers) may induce hum. To alleviate the problem, change the orientation of this unit; or move it farther away from the source of interference.
- This device may interfere with radio and television reception. Do not use this device in the vicinity of such receivers.

- Noise may be produced if wireless communications devices, such as cell phones, are operated in the vicinity of this unit. Such noise could occur when receiving or initiating a call, or while conversing. Should you experience such problems, you should relocate such wireless devices so they are at a greater distance from this unit, or switch them off.
- Do not expose the unit to direct sunlight, place it near devices that radiate heat, leave it inside an enclosed vehicle, or otherwise subject it to temperature extremes. Excessive heat can deform or discolor the unit.
- When moved from one location to another where the temperature and/or humidity is very different, water droplets (condensation) may form inside the unit. Damage or malfunction may result if you attempt to use the unit in this condition. Therefore, before using the unit, you must allow it to stand for several hours, until the condensation has completely evaporated.
- Depending on the material and temperature of the surface on which you place the unit, its rubber feet may discolor or mar the surface. You can place a piece of felt or cloth under the rubber feet to prevent this from happening. If you do so, please make sure that the unit will not slip or move accidentally.
- Do not place containers or anything else containing liquid on top of this unit. Also, whenever any liquid has been spilled on the surface of this unit, be sure to promptly wipe it away using a soft, dry cloth.

Maintenance

- For everyday cleaning wipe the unit with a soft, dry cloth or one that has been slightly dampened with water. To remove stubborn dirt, use a cloth impregnated with a mild, non-abrasive detergent. Afterwards, be sure to wipe the unit thoroughly with a soft, dry cloth.
- Never use benzene, thinners, alcohol or solvents of any kind, to avoid the possibility of discoloration and/or deformation.

Repairs and Data

- Please be aware that all data contained in the unit's memory may be lost when the unit is sent for repairs. Important data should always be backed up SD cards, SDHC cards, or written down on paper (when possible). During repairs, due care is taken to avoid the loss of data. However, in certain cases (such as when circuitry related to memory itself is out of order), we regret that it may not be possible to restore the data, and Roland assumes no liability concerning such loss of data.

Handling CDs **CD-2u** only

- Avoid touching or scratching the shiny underside (encoded surface) of the disc. Damaged or dirty discs may not be read properly. Keep your discs clean using a commercially available disc cleaner.

Additional Precautions

- Please be aware that the contents of memory can be irretrievably lost as a result of a malfunction, or the improper operation of the unit. To protect yourself against the risk of losing important data, we recommend that you have written down on paper (when possible).
- Unfortunately, it may be impossible to restore the contents of data that was stored in the unit's memory, SD cards, or SDHC cards once it has been lost. Roland Corporation assumes no liability concerning such loss of data.
- Use a reasonable amount of care when using the unit's buttons, sliders, or other controls; and when using its jacks and connectors. Rough handling can lead to malfunctions.
- Never strike or apply strong pressure to the display.
- When disconnecting all cables, grasp the connector itself—never pull on the cable. This way you will avoid causing shorts, or damage to the cable's internal elements.
- To avoid disturbing others nearby, try to keep the unit's volume at reasonable levels.
- When you need to transport the unit, package it in the box (including padding) that it came in, if possible. Otherwise, you will need to use equivalent packaging materials.
- Some connection cables contain resistors. Do not use cables that incorporate resistors for connecting to this unit. The use of such cables can cause the sound level to be extremely low, or impossible to hear. For information on cable specifications, contact the manufacturer of the cable.
- When opening/closing the CD drive (CD-2u only), please be careful not to get your fingers pinched between the movable part and the panel. In places where small children are present, make sure that an adult provides supervision and guidance.
- Please observe the following precautions when handling SD cards and SDHC cards.
 - Do not remove the device while reading/writing is in progress.
 - To prevent damage from static electricity, discharge all static electricity from your person before handling the device.
 - Avoid touching the terminals and protect them from contact with metallic objects. Make sure they stay clean.
 - Do not bend, drop, or apply strong force to the device.
 - Do not leave the device where it can be subjected to direct sunlight. Do not leave the device in locations such as a closed vehicle.
 - The device must not get wet.
 - Do not disassemble or modify the device.
- Never turn off the power or disconnect the SD cards or SDHC cards while the display indicates "Processing..."
- All SD cards and SDHC cards eventually wear out. We recommend that you consider the SD card and SDHC card not as a permanent storage site, but as a place to store data temporarily. We also recommend that you back up important performance or data that cannot be recorded again onto the another media that is supported by your unit.

Copyrights / Licenses / Trademarks

- It is forbidden by law to make an audio recording, video recording, copy or revision of a third party's copyrighted work (musical work, video work, broadcast, live performance, or other work), whether in whole or in part, and distribute, sell, lease, perform, or broadcast it without the permission of the copyright owner.
- Do not use this product for purposes that could infringe on a copyright held by a third party. We assume no responsibility whatsoever with regard to any infringements of third-party copyrights arising through your use of this product.
- MMP (Moore Microprocessor Portfolio) refers to a patent portfolio concerned with microprocessor architecture, which was developed by Technology Properties Limited (TPL). Roland has licensed this technology from the TPL Group.
- Fugue © 1999–2013 Kyoto Software Research, Inc. All rights reserved.
- The SD logo () and SDHC logo () are trademarks of SD-3C, LLC.
- This product contains eCROS integrated software platform of eSOL Co.,Ltd. eCROS is a trademark of eSOL Co., Ltd. in Japan.
- Roland is a registered trademark or trademark of Roland Corporation in the United States and/or other countries.
- Company names and product names appearing in this document are registered trademarks or trademarks of their respective owners.

About the Licenses Agreement

- The CD-2u/SD-2u's CD-writing functionality, and its backing-up functionality are designed to allow you to reproduce material to which you have copyright, or material which the copyright owner has granted you permission to copy. Accordingly, reproduction of Music CD or other copyrighted material without permission of the copyright owner avoiding technical prohibiting features of second-generation and later copying like SCMS or others constitutes copyright infringement and may incur penalties even in case such reproduction is for your own personal use and enjoyment (private use). Consult a copyright specialist or special publications for more detailed information on obtaining such permission from copyright holders.

Panel Descriptions

Top Panel

* The illustration depicts the CD-2u.

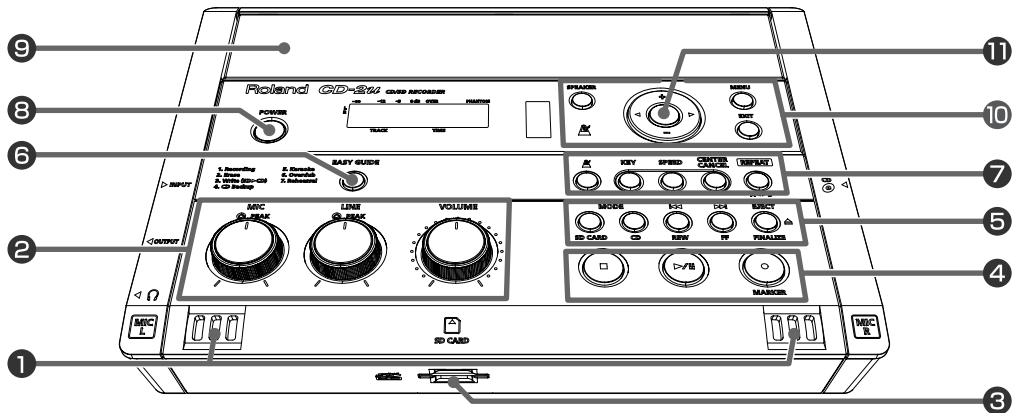

1 MIC L/MIC R

This is a stereo pair of mics built into the CD-2u/SD-2u. You can use these mics to record.

☞ “Recording with the Internal Mics” (Page 41)

2 [MIC] Knob

This adjusts the input level of the internal mics and the EXT MIC (L, R) jacks.

If the input sound is too loud, the PEAK indicator above the [MIC] knob will light.



* If you turn the [MIC] knob all the way to the left, no sound will be input from the internal mics or the EXT MIC (L, R) jacks.

* If the [MIC LEVEL] switch is in the “AUTO” position (Page 44), the input level will be set automatically, and you won’t be able to adjust the input level using the [MIC] knob.

☞ “Recording with the Internal Mics” (Page 41),
“Connecting the External Mics for Recording” (Page 45)

[LINE] Knob

This adjusts the input level of the LINE IN (L, R) jacks.

If the input sound is too loud, the PEAK indicator above the [LINE] knob will light.



* If you turn the [LINE] knob all the way to the left, no sound will be input from the LINE IN (L, R) jacks.

☞ “Recording an Electronic Instrument” (Page 50),
“Recording a Cassette or Digital Audio Player” (Page 52)

[VOLUME] Knob

This knob adjusts the volume of the internal speakers and the headphones.

☞ “Listening to a CD/Listening to an SD Memory Card” (Page 70)

3 SD Card Slot

You can insert an SD memory card here.

☞ “Preparing an SD Memory Card” (Page 26)

4 [■] (Stop) Button

This button stops playback or recording.

☞ “Listening to a CD/Listening to an SD Memory Card” (Page 70)

[▶/||] (Play) Button

This button starts playback or recording.

• During playback or recording, you can press this button to pause. Press it once again to resume playback or recording from the location at which you paused.

• If you pause recording, the next track will be started at the point you resumed recording.

☞ “Listening to a CD/Listening to an SD Memory Card” (Page 70)

[●] (Record) Button

• Press this button to enter recording-standby mode.

• During recording, you can press this button to assign a track number.

☞ “Press the [●] (Record) button to Assign a Song number” (Page 64)

5 CD-2u only MODE Button

These buttons select the audio source. The selected button will light.

[SD CARD] button	Selects “SD memory card” as the audio source.
[CD] button	Selects “CD” as the audio source.

CD-2u only [EJECT ▲] Button

Press this to eject the CD.

☞ “Removing a CD” (Page 30)

- * If an unfinalized CD-R/RW disc is inserted, a message asking whether you want to finalize the disc before ejecting will appear when you press the [EJECT] (▲) button.

☞ “Making a CD-R/RW Disc for Playback on Another CD Player (Finalize)” (Page 99)

[REVERB] Button

This button accesses the Reverb screen. The specified reverb effect will be applied.

☞ “Adding Reverberation (Reverb)” (Page 73)

[GUIDE TONE] Button

This button accesses the Tone screen. A guide tone will sound at the specified frequency.

☞ “Listening to a Guide Tone While Tuning” (Page 85)

[TUNER] Button

This button accesses the Tuner screen.

☞ “Tuning Your Instrument (Tuner Function)” (Page 83)

[◀▶] Buttons

- You can use these buttons to jump to the beginning of the preceding or the following track. During playback, the [◀] button takes you back to the beginning of the currently playing track.
 - While stopped, press and hold these buttons to rapidly move to the beginning of the track.
 - During playback, press and hold one of these buttons to rewind or fast-forward.
 - While paused, press and hold these buttons to rapidly rewind or fast-forward.
- ☞ “Listening to a CD/Listening to an SD Memory Card” (Page 70)

[EASY GUIDE] Button

This button accesses the Easy Guide screen. Here you can record or create a CD by following the on-screen instructions.

☞ “About Easy Guide” (Page 37)

[M] (Metronome) Button

This turns the metronome on/off.

☞ “Sounding the Metronome” (Page 81)

[KEY] button

This button changes the pitch of the playback sound.

☞ “Changing the Key of the Playback” (Page 75)

☞ “Making Fine Adjustments to the Playback Pitch (Pitch)” (Page 76)

[SPEED] button

This button changes the playback speed.

☞ “Slowing Down or Speeding Up Playback” (Page 77)

[CENTER CANCEL] button

This button eliminates or minimizes the sound heard from the center, such as the main vocal of the song.

☞ “Enjoying Simple Karaoke (Center Cancel)” (Page 78)

[REPEAT] Button

This button repeatedly plays back the region you specify.

☞ “Repeatedly playing a portion of the song (A/B

Repeat)” (Page 80)

[POWER] Switch

This turns the power on/off.

☞ “Using the Dedicated AC Adaptor” (Page 22),

☞ “Using Batteries” (Page 24)

[SPEAKERS] Stereo Speakers

These are a pair of stereo speakers built into the CD-2u/SD-2u.

[METRONOME] Metronome Indicator

This will blink if the metronome is on.

☞ “Sounding the Metronome” (Page 81)

[SPEAKER] button

This button turns the speaker on/off.

☞ “Muting the Sound of the Speakers” (Page 74)

[MENU] Button

- This button accesses the menu screen. Here you can make settings for recording/playback, and settings for the CD-2u/SD-2u itself.

☞ “Menu Operations” (Page 33)

[EXIT] Button

- After you’ve modified the setting for a menu item, press this to return to the audio source display.
- Press this to answer “no” to messages shown in the display.

[MENU] Function Buttons

These buttons are used mainly to perform menu operations.

☞ “Menu Operations” (Page 33)

[◀] [▶] Buttons (Left/Right)

These buttons select menu items from a menu screen.

- * From the audio source display, pressing the [◀] [▶] buttons will access a screen where you can specify the playback level of the player (SD/CD).

☞ “Recording Karaoke” (Page 54)

☞ “Layering Your Performance onto an SD Memory Card Song and Recording It” (Page 59)

[+] [-] Buttons (Up/Down)

These buttons modify the value of a menu item.

- * From the audio source display, pressing the [-] button will access a screen where you can confirm whether you want to delete the song.

☞ “Deleting Songs Individually” (Page 86)

☞ “Deleting One Song at a Time (Only the Last Song)” (Page 92)

[ENTER] Button (Center)

- This button confirms a menu item and displays a screen where you can edit that item.
- Press this to answer “yes” to messages shown in the display.

Display

The display shows information or messages related to the operation you're performing, such as when you're making various settings or editing tracks.

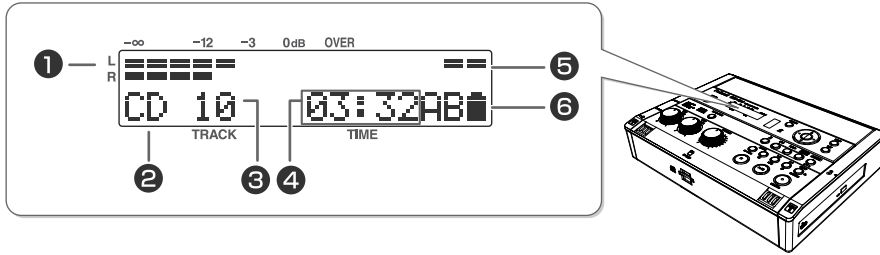

1 LEVEL Meter

This indicates the volume level of the track that's playing or the instrument or mic that's being input.

2 Source Name Indicator

This indicates the name of the currently selected audio source.

3 TRACK Indicator

This indicates the track number.

4 TIME Indicator

This indicates the elapsed playback or recording time.

You can switch the time information that's shown here

☞ "Viewing the Remaining Recording/Playback Time" (Page 112)

5 Phantom power indicator

This indicates the phantom power on/off status.

6 Symbol Indicators

R1	Displayed during one-track repeat playback. ☞ Page 79
RA	Displayed during all-track repeat playback. ☞ Page 79
AB	Displayed during A-B repeat playback. ☞ Page 80
	This is shown if the CD-2u/SD-2u is running on batteries. It indicates the remaining battery power.

Right Side Panel

CD-2u only

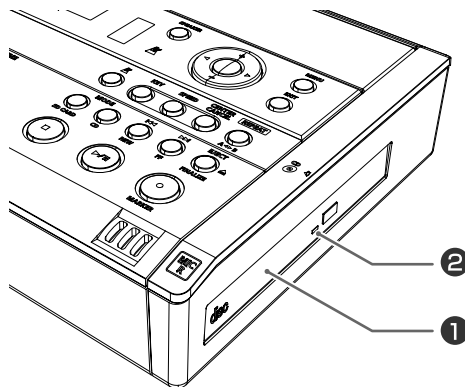

1 CD-2u only CD Tray

This is where you insert a CD.

☞ "Inserting a CD" (Page 29)

2 CD-2u only Emergency Eject Hole

You can use this to remove the CD in case of emergency. Normally, it is not used.

☞ "If You are Unable to Eject the Disc" (Page 30)

Left Side Panel

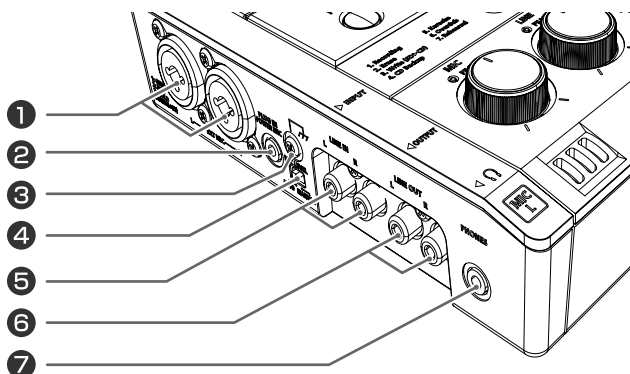
**1 EXT MIC (L, R) jacks (XLR/TRS combo type)**

Connect external mics to these jacks.
These XLR connectors can supply phantom power.

- ☞ “Connecting the External Mics for Recording” (Page 45)
- ☞ “Using Phantom Power” (Page 49)

* This instrument is equipped with balanced (XLR/TRS) type jacks. Wiring diagrams for these jacks are shown below. Make connections after first checking the wiring diagrams of other equipment you intend to connect.

**2 PLUG IN POWER MIC jack**

Connect a plug in power mic to this jack.

- ☞ “Connecting the External Mics for Recording” (Page 45)

3 Ground Terminal

Connect this to an external electrical ground.

Depending on the circumstances of a particular setup, you may experience a discomforting sensation, or perceive that the surface feels gritty to the touch when you touch this device, microphones connected to it, or the metal portions of other objects, such as mics. This is due to an infinitesimal electrical charge, which is absolutely harmless. However, if you are concerned about this, connect the ground terminal with an external ground. When the unit is grounded, a slight hum may occur, depending on the particulars of your installation. If you are unsure of the connection method, contact the nearest Roland Service Center, or an authorized Roland distributor, as listed on the “Information” page.

Unsuitable places for connection

- Water pipes (may result in shock or electrocution)
- Gas pipes (may result in fire or explosion)
- Telephone-line ground or lightning rod (may be dangerous in the event of lightning)

4 [MIC LEVEL] Switch

This selects how the mic input level is to be adjusted.

Switch position	Explanation
MANUAL	The [MIC] knob will adjust the mic’s input level.
AUTO	The mic input level will be adjusted automatically. Operating the [MIC] knob will not affect the input level.

- ☞ “Recording Acoustic Instruments or Vocals” (Page 41)
- ☞ “Adjusting the Input Level Automatically (Auto Level Function)” (Page 44)

5 LINE IN (L, R) jacks

Connect an electronic piano, keyboard, cassette deck, etc. to these jacks.

- ☞ “Recording an Electronic Instrument” (Page 50),
- ☞ “Recording a Cassette or Digital Audio Player” (Page 52)

6 LINE OUT (L, R) jacks

Use this jack to output analog audio signals to an external speaker system or electronic piano.

- ☞ “Connecting External Speakers” (Page 123)
- You can choose the audio signal that will be output from the LINE OUT jack.
- ☞ “Selecting the Audio Source that’s Sent from the LINE OUT Jack” (Page 124)

7 PHONES jack

You can connect a set of headphones to this jack.

- * If headphones are connected, there will be no sound from the speakers.
- ☞ Step 4 on “Recording with the Internal Mics” (Page 41)

Rear Panel/Bottom Panel

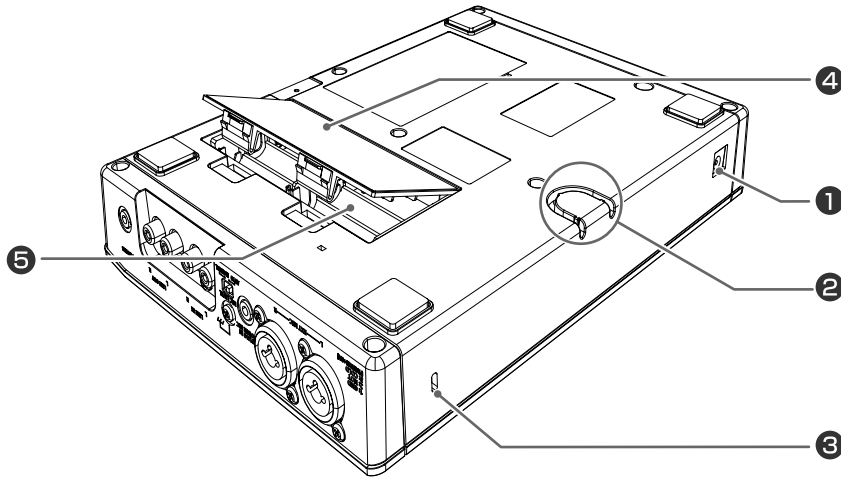
**1 DC IN Connector**

Connect the dedicated AC adaptor (included) here.

☞ “Using the Dedicated AC Adaptor” (Page 22)

2 Cord Hook

Use this cord hook to fasten the cord of the dedicated AC adaptor (included) so that it doesn't become accidentally unplugged.

☞ “Using the Dedicated AC Adaptor” (Page 22)

3 Security Slot ()

<http://www.kensington.com/>

4 Battery Cover

☞ “Using Batteries” (Page 24)

5 Battery Compartment

Install batteries here if you want to operate the CD-2u/SD-2u on batteries.

If you're using the dedicated AC adaptor, it's not necessary to install batteries.

☞ “Using Batteries” (Page 24)

Note

Even if batteries are installed, the unit will turn off if you connect or disconnect the power cord from the AC outlet while the unit is turned on, or if you connect or disconnect the AC adaptor from the unit. When this occurs, unsaved data may be lost. You must turn off the power before you connect or disconnect the power cord or AC adaptor.

Remote Control

Performs record/playback operations for the CD or SD memory card. These have the same function as the buttons on the CD-2u/SD-2u itself.

Center Cancel

- Turns Center Cancel on/off.

Metronome settings

- FAST** Makes the metronome tempo faster.
- SLOW** Makes the metronome tempo slower.
- Turns the metronome on/off.

Playback speed settings

- FAST** Makes the playback faster.
- SLOW** Makes the playback slower.
- Turns the playback speed setting on/off.

Playback key settings

- UP** Raises the key of the playback sound.
- DOWN** Lowers the key of the playback sound.
- Turns the key setting on/off.

Note

The [VOLUME] knob of the CD-2u/SD-2u itself does not move when you adjust the volume from the remote control. This may cause the actual volume to no longer match the position of the [VOLUME] knob.

If you're using headphones, use the [VOLUME] knob of the CD-2u/SD-2u itself to lower the volume before you start listening. This will help prevent high volume from damaging your hearing.

Important

For details on installing batteries in the remote control and using the remote control, refer to "Preparing the Remote Control" (Page 31).

Attaching the CD-2u or SD-2u to a stand

By using the separately sold SS-PC1, you can attach the CD-2u or SD-2u to a stand as shown in the illustration





- * When you using the SS-PC1, extend the legs to their maximum spread. Do not allow the overall height including the CD-2u or SD-2u to exceed 1 meter (approx. 3.3 feet).
- * The SS-PC1 must be carefully placed so it is level and sure to remain stable.
- * Please be mindful of any safety issues before using this product



Recordable Media and Functionality

As its recording media, this device uses ① SD memory cards, and the CD-2u additionally allows you to use ② CD-R discs and ③ CD-RW discs. The functions available for editing or deleting songs (tracks) after recording will differ according to the media you use.

The table below shows the functions available for each type of media.

		Media			
		SD memory card	CD-R disc CD-2u only	CD-RW disc CD-2u only	Music CD CD-2u only
CD-2u/SD-2u function					
Recording	Conventional recording	✓	✓	✓	
	Overdubbing	✓			
Playback		✓	✓	✓	✓
Edit tracks		✓			
Delete tracks		✓		✓	
Cancel finalization (Page 94)				✓	
Create an original music CD			✓	✓	
Backup an original music CD			✓	✓	

- * In order for a CD-R/RW disc recorded on the CD-2u/SD-2u to be playable on another CD player, an operation called “finalizing” (Page 99) must be performed on that disc.
- * We cannot guarantee that a music CD created on the CD-2u/SD-2u will play on all CD players. Depending on your CD player’s support for CD-R/RW discs, music CDs you create may or may not play correctly.
- * The CD-2u and the SD-2u support SDHC memory cards (up to 16 GB).
- * Some SD memory card types or SD memory cards from some manufacturers may not record or play back properly on the CD-2u/SD-2u.

Differences between CD-R discs and CD-RW discs

CD-2u only

Unlike conventional music CDs, both of these discs allow recording.

A song recorded on a CD-R (Compact Disc Recordable) disc cannot be erased later.

You should use CD-R discs in the following cases.

- To record an important performance
- To create a CD from songs you’ve recorded on an SD memory card
- To back up an original music CD

CD-RW (Compact Disc ReWritable) discs allow you to erase a song you’ve recorded.

Songs can be erased one by one starting at the last-recorded song, or you can erase all songs in a single operation.

CD-RW discs can be recorded and erased approximately 1,000 times.

You should use CD-RW discs in the following cases.

- To record your practicing
- To Make a “sketchpad” of your musical ideas

Minimum Recording Time for One Track

In order to allow music CDs to be created from the songs you record, the minimum recording time for one song on this unit is four seconds.

Pressing [■] (Stop) or [▶/II] (Pause) will not stop recording if less than four seconds have passed since you began recording. Moreover, you cannot assign a track number (Page 64) in such cases.

In Case Your Performance is Not Recordable

Further recording is not possible once you've reached the maximum recordable time or the maximum number of songs that can be recorded.

- If there is no more recordable time, the message "SD Card Full" or "CD Disc Full" will appear.
- If the maximum number of tracks have already been recorded, the message "SD Track Full" or "CD Track Full" will appear.

This message goes away when you press the [ENTER] button.

If you're using an SD memory card or a CD-RW disc, you can erase unwanted songs (Page 86, 92) and then continue recording.

When Recording on an SD memory card

■ Data Format

Wave (Stereo)

- Sampling Rate: 44.1 kHz
- Bit Depth: 16 bits

* CD-2u/SD-2u only supports above data format.

■ Recording Modes and Maximum Recording Times

Capacity	Maximum recording time (approx.)
1 GB	94 minutes (1 hour 34 minutes)
2 GB	189 minutes (3 hours 9 minutes)
4 GB	377 minutes (6 hours 17 minutes)
8 GB	755 minutes (12 hours 35 minutes)
16 GB	1511 minutes (25 hours 11 minutes)

* The maximum times given above are approximate. The actual time may be slightly less depending on how tracks have been edited.

- * You can view the remaining time in the display.
 - ☞ "Viewing the Remaining Recording/Playback Time" (Page 112)

■ Recording Time for One Track (One Song)

The maximum length of one track is 74 minutes.

If a recording exceeds 74 minutes, a new track division will automatically be created.

■ The Number of Recording Tracks

A maximum of 99 tracks can be recorded on one SD memory card.

When Recording on a CD-R/RW disc CD-2u only

You must use the dedicated AC adaptor when recording on a CD-R/RW disc.

■ Maximum Recording Times

Capacity	Maximum recording time
650 MB	approximately 74 minutes
700 MB	approximately 80 minutes

* The maximum times given above are approximate. The actual time may be slightly less depending on the number of tracks that are recorded.

- * You can view the remaining time in the display.
 - ☞ "Viewing the Remaining Recording/Playback Time" (Page 112)

■ Types of Discs that You Can Record

- Blank CD-R discs
 - "Blank disc" refers to an "empty" disc on which nothing has been recorded or stored.
- Partially recorded (not yet finalized) CD-R discs

■ The Number of Recording Tracks

A maximum of 99 tracks can be recorded on one CD-R/RW disc.

■ Recorded Songs

When you record on a CD-R/RW disc, a blank space of two seconds will automatically be added at the end of each track (song).

■ Finalization

"Finalization" is a process that can be applied to a CD-R/RW disc so that it will be playable by a conventional CD player. Once a CD-R disc or CD-RW disc has been finalized, it can be played back as a music CD in a CD player that supports CD-R or CD-RW playback.

For more information, refer to "Making a CD-R/RW Disc for Playback on Another CD Player (Finalize)" (Page 99).

- * No further songs can be recorded on a CD-R/RW disc that has been finalized.
- If you're using a CD-RW disc, you can remove the finalization and add additional material.
 - ☞ "Removing Finalization" (Page 94)

Turning the Power On and Off

You can operate the CD-2u/SD-2u either with the dedicated AC adaptor, six alkaline batteries (AA, LR6, sold separately), or rechargeable Ni-MH batteries (AA, HR6, sold separately).

- * Before turning the unit on/off, always be sure to turn the volume down. Even with the volume turned down, you might hear some sound when switching the unit on/off. However, this is normal and does not indicate a malfunction.

Using the Dedicated AC Adaptor

If you're using the dedicated AC adaptor, batteries are not required.

- * Even if batteries are installed, the unit will turn off if you connect or disconnect the power cord from the AC outlet while the unit is turned on, or if you connect or disconnect the AC adaptor from the unit. When this occurs, unsaved data may be lost. You must turn off the power before you connect or disconnect the power cord or AC adaptor.

1 Connect the power.

- * Place the AC adaptor so the side with the indicator (see illustration) faces upwards. The indicator will light when you plug the AC adaptor into an AC outlet.

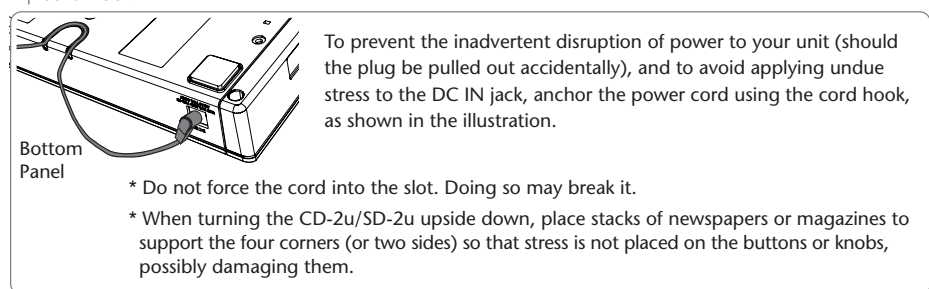
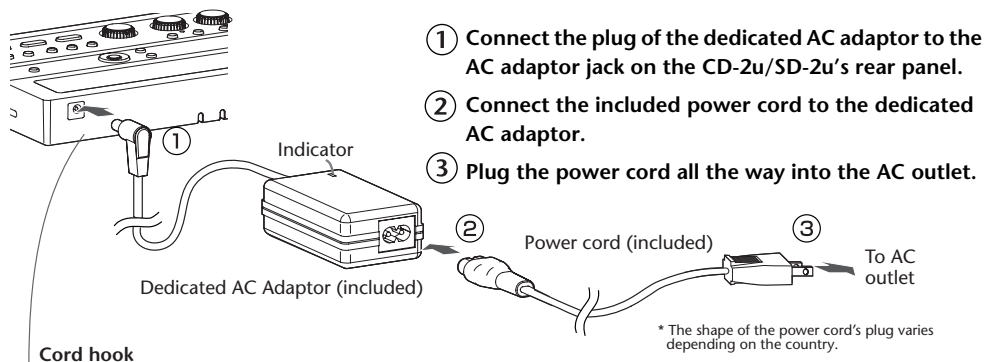

2 Press and hold the [POWER] switch.

When the screen appears in the display, release the switch.

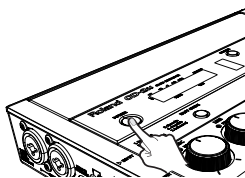

- * This unit is equipped with a protection circuit. A brief interval (a few seconds) after turning the unit on is required before it will operate normally.

Turning the Power Off

- 1 Press and hold the [POWER] switch until the shutdown screen appears in the display.

* Do not disconnect the AC adaptor until the display backlight turns off.

About the Auto Off function

The power to this unit will be turned off automatically after a predetermined amount of time has passed since it was last used for recording a performance, playing music, or its buttons or controls were operated (Auto Off function).

If you do not want the power to be turned off automatically, disengage the Auto Off function.

- 1 Press the [MENU] button to access the menu screen, and choose "Auto Off."

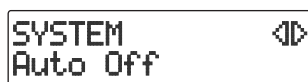

- ① Press the [MENU] button to access the menu screen.
- ② Use the [+] [-] buttons to choose "SYSTEM."
- ③ Use the [<] [>] buttons to choose "Auto Off."
- ④ Press the [ENTER] button to confirm your choice.

- 2 Use the [+] [-] buttons to change the value for the Auto Off function.

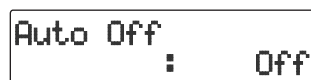

Value	Explanation
Off	The power will not turn off automatically. Use the [POWER] switch to turn the power on/off.
5 min	Power will automatically turn off when the specified time has elapsed following the last operation.
10 min	
15 min	
30 min	
60 min	
90 min	
120 min (Factory Setting)	

- 3 Press the [EXIT] button twice.
You are returned to the audio source screen.

Using Batteries

Note

CD-2u only

If you're operating the CD-2u/SD-2u on batteries, you won't be able to perform CD-related operations such as recording, playing, or writing songs, etc.

- * If operating this unit on batteries, please use alkaline batteries or rechargeable Ni-MH batteries.
- * If operating this unit on batteries, please disconnect the AC adaptor from this unit.
- * Even if batteries are installed, the unit will turn off if you connect or disconnect the power cord from the AC outlet while the unit is turned on, or if you connect or disconnect the AC adaptor from the unit. When this occurs, unsaved data may be lost. You must turn off the power before you connect or disconnect the power cord or AC adaptor.

1 Turn the power off.

Disconnect all cables from the CD-2u/SD-2u.

2 Turn the CD-2u/SD-2u upside down and remove the battery cover.

- * When turning the unit upside down, take precautions to ensure that the buttons and knobs are protected from damage. Also, be sure to handle the unit with care so as to avoid dropping it, or allowing it to fall or tip over.

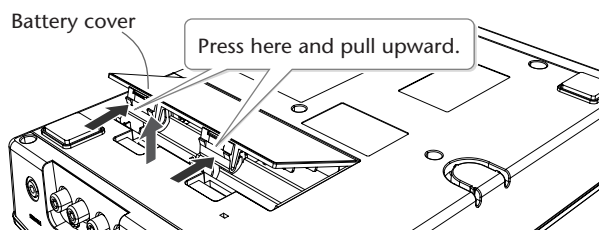

3 Install six alkaline batteries (AA, LR6) or rechargeable Ni-MH batteries (AA, HR6).

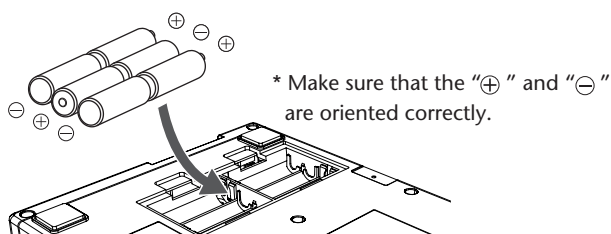

4 Close the battery cover and turn the CD-2u/SD-2u right side up.

5 Press and hold the [POWER] switch.

Release the switch when the screen appears in the display.

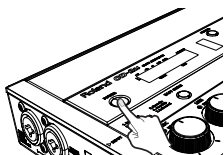

6 Set the "Battery Type" (Page 36) parameter in the menu to specify the type of batteries you're using.

Turning the Power Off

1 Press and hold the [POWER] switch until the shutdown screen appears in the display.

- * Do not disconnect the AC adaptor until the display backlight turns off.

Remaining Battery Indicator

If you're operating the CD-2u/SD-2u on batteries, the battery indicator will be shown on the screen.

If you continue use the CD-2u/SD-2u when the batteries are low, the display will indicate "Battery Low," and eventually the power will turn off.

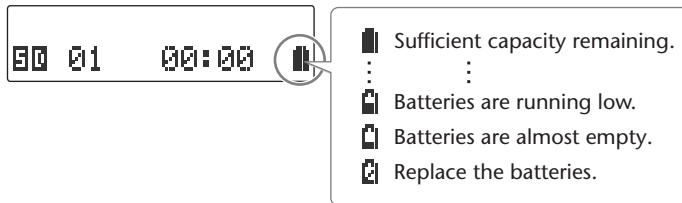

- * The remaining battery indicator is only an approximation.

Battery Life

Expected battery life under continuous use:

Alkaline battery: Approx. 5.5 hours

Rechargeable Ni-MH battery: Approx. 6 hours

- * These figures will vary depending on the specifications of the batteries and the actual conditions of use.

Note

Even if batteries are installed, the unit will turn off if you connect or disconnect the power cord from the AC outlet while the unit is turned on, or if you connect or disconnect the AC adaptor from the unit. When this occurs, unsaved data may be lost. You must turn off the power before you connect or disconnect the power cord or AC adaptor.

Important

- If operating this unit on batteries, please disconnect the AC adaptor from this unit.
- Carefully follow the installation instructions for batteries, and make sure you observe the correct polarity.
- Avoid using new batteries together with used ones. In addition, avoid mixing different types of batteries.
- Remove the batteries whenever the unit is to remain unused for an extended period of time.
- Never keep batteries together with metallic objects such as ballpoint pens, necklaces, hairpins, etc.
- Used batteries must be disposed of in compliance with whatever regulations for their safe disposal that may be observed in the region in which you live.
- Incorrect handling of batteries, rechargeable Ni-MH batteries, or a battery charger can cause leakage, overheating, fire, or explosion. Before use, you must read and strictly observe all of the precautions that accompany the batteries, rechargeable batteries, or battery charger.
- When using rechargeable batteries and a charger, use only the combination of rechargeable batteries and charger specified by the battery manufacturer.

Preparing an SD Memory Card

Here's how to prepare an SD memory card for recording.

- * The CD-2u and the SD-2u support SDHC cards (up to 16 GB).
- * Some SD memory card types or SD memory cards from some manufacturers may not record or play back properly on this unit.

Inserting an SD Memory Card

- 1 Insert the SD memory card into the SD card slot on the CD-2u/SD-2u's front panel.

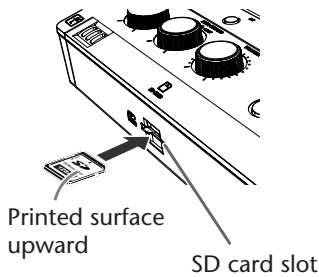

With the printed surface of the SD memory card facing upward, insert the card until it clicks into position.

- * Carefully insert the SD cards or SDHC cards all the way in-until it is firmly in place.

Displayed screen	Status of the SD memory card
<p>Audio source</p>	Nothing has been recorded yet.
<p>Total number of tracks Total playback time</p>	<p>A song has been recorded.</p> <p>* If the SD memory card has already been recorded, the total number of songs and the total playback time will be displayed when the SD memory card information is loaded.</p>
	<p>This SD memory card cannot be used by the CD-2u/SD-2u in its current state.</p> <p>* If this message is shown, you'll need to format the card before using it with the CD-2u/SD-2u. For details, refer to the section on the following page entitled "If the screen indicates "Unknown Format"" (Page 27).</p>

The SD memory card write protect feature (LOCK)

The contents of the SD memory card can be protected by write protecting it. To write protect a card, slide the write protect switch on the side of the SD memory card to the "LOCK" position.

Unlock write protect to record, edit, or delete data on the card.

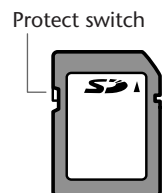

If the screen indicates “Unknown Format”

In some cases when you insert an unused SD memory card that you purchased at a consumer electronic retailer, or an SD memory card that has been used with a computer or digital camera, the screen may indicate “Unknown Format. Format?”

In order to use this SD memory card with the CD-2u/SD-2u, you’ll need to format the card. Proceed as follows to format the card.

Note

- Never turn off the power or disconnect the SD cards, SDHC cards while the screen indicates “Processing...”
- When you format an SD memory card, any data that was on that card will be erased. Data that’s been lost in this way cannot be recovered. Please make sure that you really want to format the card.

1 To begin formatting, press the [ENTER] button.



2 If you’re sure you want to proceed, press the [ENTER] button.

(Note that the process cannot be interrupted once you’ve started it. If you decide that you don’t want to begin the process, press the [EXIT] button.)



The screen will indicate “Processing..,” and the card will be formatted. When formatting is completed, you’re returned to the audio source screen.

Using the Included SD Memory Card Protector

You can use the included SD memory card protector to prevent theft of an SD memory card inserted in the CD-2u/SD-2u.

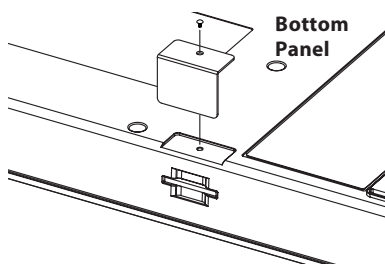

- ① Remove the screw from the bottom panel.
- ② Use the removed screw to attach the protector.

- * When fastening the screw, take care not to overtighten it. Doing so may strip the threads or the head of the screw.
- * Take care not to lose the screw.
- * Keep the removed screw out of the reach of small children so that it will not be swallowed accidentally.

Removing an SD Memory Card

Note

Never insert or remove an SD memory card while this unit's power is on. Doing so may corrupt the unit's data or the SD memory card.

- 1** Turn the power off (☞ Page 23, 25).
- 2** Gently press the SD memory card inward, and then release your finger.
When the memory card pops part of the way out, pull it all the way out.

Demo Songs on the SD Memory Card

The included SD memory card contains demo songs.

File name	Explanation
01_PIANO.WAV	Piano performance recorded using this unit's built-in microphones.
02_GUITAR.WAV	Acoustic guitar performance recorded using this unit's built-in microphones.
03_VIOLIN.WAV	Violin performance recorded using this unit's built-in microphones.
04_QUARTET.WAV	String quartet recorded using this unit's built-in microphones.
05_WINDS_ENS.WAV	Wind instrument ensemble recorded using condenser microphones connected to the EXT MIC (L, R) jacks. Song Title: VIVA! MEMOCON Composer: MASAMICHI AMANO
06_IM_IN_LOVE.WAV	A rock band's performance created using a different recorder and production system. You can use this song to hear the results of changing the speed or key, and to try out the Center Cancel and Focus effects. The name of the song is "I'm In Love," by Igor Len and Tyra Juliette. Recorded and produced by Igor Len.

Note

Copyright © 2013 ROLAND CORPORATION
The demo songs on the included SD memory card may not be modified, duplicated, distributed, or transferred without the permission of Roland Corporation.

Here's how to prepare a CD-R/RW disc for recording or a music CD for playback.

Inserting a CD

Note

- Don't use CD labels, or CDs that have labels or stickers affixed to them. Doing so may make the CD impossible to remove, and may damage the unit.
- When opening/closing the CD-R/W drive, please be careful not to get your fingers pinched between the movable part and the panel. In places where small children are present, make sure that an adult provides supervision and guidance.

1 Press the [CD EJECT (▲)] button.

The tray will open partially. Use your hand to pull it open.

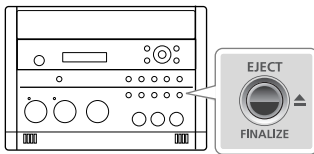

2 Place the CD in the tray.

Make sure that the CD is securely locked onto the spindle.

3 Press the tray inward to close it.



Screen display	CD status
<p>Audio source</p>	Nothing has been recorded yet.
<p>Total number of tracks Total playback time</p>	<p>Songs have been recorded (or written).</p> <p>* In the case of an already-recorded (or written) CD-R/RW disc or music CD, the total number of songs and the total playback time will be displayed once the CD information has been read.</p>

Removing a CD

1 Press the [EJECT (▲)] button.

After the CD has been ejected, pull it all the way out.

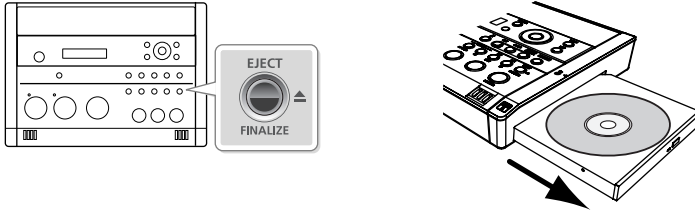

If the screen shows “Finalize Are You Sure?”

Finalize
Are You Sure?

If the CD-R/RW disc has not been finalized, a message will ask “Finalize Are You Sure?” If you don’t want to finalize the disc for playing on other CD players, press the [EXIT] button and remove the disc after it’s been ejected.

For details on finalizing, refer to “Making a CD-R/RW Disc for Playback on Another CD Player (Finalize)” (Page 99).

Finalize	Response
Yes	Press the [ENTER] button. The CD-RW disc will be finalized and then ejected.
No	Press the [EXIT] button. The CD-R/RW disc will be ejected.

If You are Unable to Eject the Disc

If pressing the [EJECT ▲] button does not eject the disc, you can use the emergency eject hole to forcibly eject the CD.

* Before using the emergency eject hole to eject the CD, you must turn off the power of the CD-2u/SD-2u.

1 Turn off the power (⏻ Page 23).

2 Insert a thin wire (such as a straightened paper clip) into the emergency eject hole.

Insert and remove the wire repeatedly until the CD comes out.

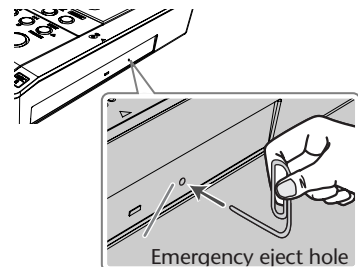

Preparing the Remote Control

When shipped from the factory, a coin-type lithium battery is installed in the remote control unit. To start using the remote control unit, simply pull out the insulating sheet that extends from the battery compartment.

Replacing the Remote Control's Battery

Install a coin-type lithium battery in the remote control.

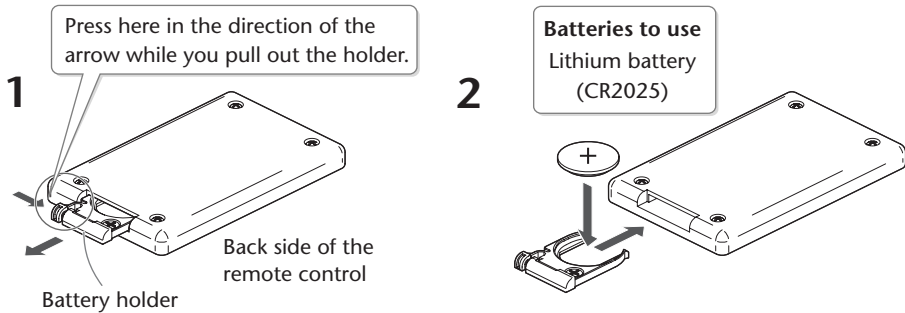

* Handle lithium batteries carefully

- Use only the specified type (model no. CR2025) of lithium batteries. Be sure to insert it as directed (to ensure correct polarity).
- Used lithium batteries must be disposed of in compliance with whatever regulations for their safe disposal that may be observed in the region in which you live.



- 1 Pull out the battery holder.**
- 2 Insert a lithium battery (CR2025) as shown in the illustration.**
- 3 Replace the battery holder.**
Push it inward until it clicks into place.

Using the Remote Control

Point the remote control toward the CD-2u/SD-2u's sensor, and operate it within the specified operating range.

When the remote sensor detects a remote control operation, the [ENTER] button will blink.

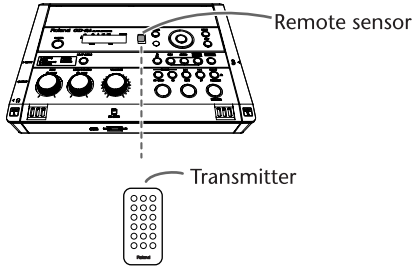

- * Even if the remote control is within range, it may not work if there is an obstruction between it and the remote sensor, or if the angle is excessive.
- * The battery life will depend on the conditions of use. When the battery runs down, the operating angle will become narrower. Replace the battery if this occurs.
- * If you won't be using the remote control for an extended period of time, remove the battery.
- * If a spotlight or other strong light is directed at the remote sensor, it will be less responsive.

Disabling Remote Control Operation

If you want to prevent inadvertent operation of the remote control, you can disable remote operation.

- 1** Press the [MENU] button to access the menu screen, and choose "Remote Control."



- ① Press the [MENU] button to access the menu screen.
- ② Use the [+] [-] buttons to choose "SYSTEM."
- ③ Use the [<] [>] buttons to choose "Remote Control."
- ④ Press the [ENTER] button to confirm your choice.

- 2** Use the [+] [-] buttons to turn the remote control operation on/off.



Value	Explanation
Off	Remote operation will be disabled (off).
On (factory setting)	Remote operation will be enabled (on).

- 3** Press the [EXIT] button twice.
You're returned to the audio source screen.

Menu Operations

When you press the [MENU] button, the menu screen will appear. In the menu screen you can make settings for recording/playback, and settings for the CD-2u/SD-2u itself.

You can also press the [Metronome], [KEY], [SPEED], or [CENTER CANCEL] button to access the specific menu screen for those functions.

The menu screen cannot be displayed while in recording-standby mode or during recording. Also, there are some settings that cannot be operated while the unit is operating on batteries, or during playback.

For details on each setting, refer to "List of Settings" on the following page.

1 Press the [MENU] button to access the menu screen.

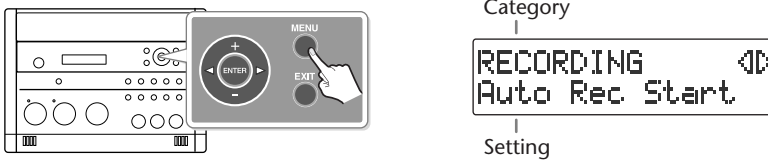

2 Use the [<] [>] buttons to choose the item you wish to set.

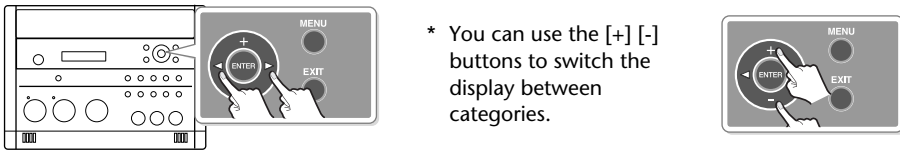

3 Press the [ENTER] button to confirm your choice.

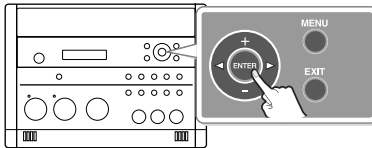

4 Use the [+] [-] buttons to change the value.

* Some items, such as SD memory card editing, do not have a value.

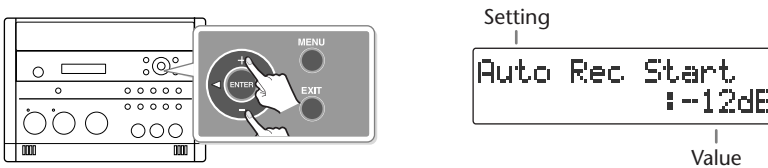

5 Press the [EXIT] button twice to return the audio source screen.

Pressing the [EXIT] button once will take you back to the menu screen.

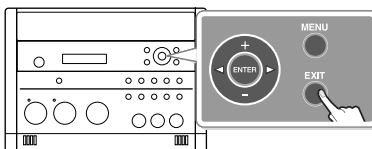

List of Settings

- * The default value (factory setting) is printed in bold characters.
- * The ✓ symbol in the “Battery” or “Playback” column indicates a setting that can be made while the CD-2u/SD-2u is running on batteries or playing back.

Category	Setting (details)	Values	Battery	Playback	Reference page
Audio	MIC Select (Selects either the built-in mics or the external mics.)	Internal , External, Ext(MONO), Plug-In Power, Auto	✓		
	Phantom Power (Determines whether phantom power will be supplied to the external mics.)	Off , On	✓		
	Plug-In Power (Specifies whether or not power will be supplied to an external plug-in power mic.)	Off , On	✓		
	EXT MIC Sens (Adjusts the sensitivity of the external mic.)	Low, High	✓		Page 48
	INT MIC Balance (Adjusts the left/right volume balance of the internal mics.)	L50–C–R50	✓		Page 120
	INT MIC Exchange (Exchanges the left and right channels of the internal mics.)	Off , On	✓		Page 121
	Limiter (Automatically adjusts the input level during recording so that loud sounds will not cause distortion.)	Off , On	✓		Page 67
	OUTPUT Select (Specifies the audio source that will be output from the LINE OUT jack.)	(CD-2u) Mix1, Mix2, MIC, LINE, SD/CD (SD-2u) Mix1, Mix2, MIC, LINE, SD	✓		Page 124
OUTPUT Exchange (The recorded song will play back with the left and right audio channels exchanged.)	Off , On	✓		Page 74	
RECORDING	Auto Rec Start (Automatically initiates recording when audio input is detected.)	Off , -48dB, -36dB, -24dB, -12dB, -6dB	✓	✓	Page 62
	Auto Marker (Automatically adds a song number while recording.)	Off , Time, Level	✓	✓	Page 65 Page 66
	Auto Marker Lvl (Specifies the audio level that will be considered to be silence when automatically adding song numbers during recording.)	-60dB , -54dB, -48dB, -42dB, -36dB, -30dB, -24dB	✓	✓	Page 66
	Auto Marker Time (Specifies the time interval at which song numbers will automatically be added during recording.)	2min –15min	✓	✓	Page 65
	Count-in (Beat) (Inserts a count-in at the beginning of recording.)	Off , 1–16	✓	✓	Page 68
PLAYBACK	Repeat (Repeatedly plays one song or all songs.)	Off , 1 Track, All Tracks	✓	✓	Page 79
	Resume (Remembers the location at which the song was stopped, and resumes playback from that point the next time.)	Off , On	✓	✓	Page 71
	Bass (Adjusts the tone of the low-frequency range.)	-10– 0 –10	✓	✓	Page 72
	Treble (Adjusts the tone of the high-frequency range.)	-10– 0 –10	✓	✓	Page 72
	Reverb CD-2u _{only} (Adds reverberation.)	Off , Light, Medium, Deep	✓	✓	Page 73

Category	Setting (details)	Values	Battery	Playback	Reference page
SD CARD	Erase One? (Deletes the selected song.)	—	✓		Page 86
	SD Erase All? (Deletes all songs.)	—	✓		Page 87
	Move? (Moves the song.)	—	✓		Page 103
	Trim In? (Deletes silence from the beginning of the song.)	—	✓		Page 88
	Trim Out? (Deletes silence from the end of the song.)	—	✓		Page 90
	Divide? (Divides the song in two.)	—	✓		Page 104
	Combine? (Joins two songs into a single song.)	—	✓		Page 106
	Normalize? (Maximizes the volume of the entire song.)	—	✓		Page 107
	Change Key? (Changes the key of the selected song, and creates a new song.)	-12-0-12	✓		Page 108
	Change Pitch? (Changes the pitch of the selected song, and creates a new song.)	-100-0-100	✓		Page 109
	Change Speed? (Changes the playback speed of the selected song, and creates a new song.)	50-100-200	✓		Page 110
	Center Cancel (Eliminates the audio heard from the center of the song, and creates a new song.)	On1, On2, On3, Focus1, Focus2	✓		Page 111
	Overdub CD→SD? CD-2u _{only} (Layers a performance or vocal onto a CD song.)	—			Page 54
	Overdub SD→SD? (Records another performance or vocal onto a song you recorded on an SD memory card.)	—	✓		Page 59
Format? (Formats the SD memory card.)	—	✓		Page 119	
Card Info (Displays information about the SD memory card.)	—	✓		Page 113	
CD-R/RW CD-2u _{only}	Erase Last? CD-2u _{only} (Deletes the last song from the CD-RW disc.)	—			Page 92
	CD Erase All? CD-2u _{only} (Deletes all songs from the CD-RW disc.)	—			Page 93
	Unfinalize? CD-2u _{only} (Removes finalization from the CD-RW disc.)	—			Page 94
	Make Backup? CD-2u _{only} (Backs up an original music CD.)	—			Page 100
	Write (SD→CD)? CD-2u _{only} (Creates a CD from the selected songs of the SD memory card.)	—			Page 95
	Disc Info CD-2u _{only} (Displays information about the CD-R/RW disc.)	—			Page 114
TUNER	Tuner/Tone? (Activates the tuner or sounds a tuning reference tone.)	"Pitch" 435-440-445	✓		Page 84
		"Tone" A3-A4-A5	✓		Page 85

Category	Setting (details)	Values	Battery	Playback	Reference page
SYSTEM	Auto Off (Enables/disables automatic power-off when no panel operation has been performed for a specified length of time.)	Off, 5min, 10 min, 15,min, 30 min, 60 min, 90 min, 120 min	✓		Page 23
	Battery Type (Specifies the type of battery to be used. This setting makes it possible for the remaining battery power to be indicated accurately.)	Alkaline, Ni-MH	✓		
	Remote Control (Enabled/disables remote control operation.)	Off, On	✓	✓	Page 32
	Contrast (Adjusts the visibility of the characters in the screen.)	1–5–8	✓	✓	Page 115
	Backlight Timer (Specifies the time until the screen will be dimmed.)	Off, 2 sec, 5 sec, 10 sec, 20 sec	✓	✓	Page 116
	Language (ゲンゴ) (Selects the screen display language.)	EN English , JP ニホンゴ ES Español, DE Deutsch FR Français, IT Italiano	✓		Page 117
	Factory Reset? (Returns the menu settings to their factory-set state.)	—	✓		Page 118

Category	Setting (details)	Values	Battery	Playback	Reference page
METRONOME	Sound (Specifies the metronome sound.)	Silent, Bell , Click, Voice	✓	✓	Page 81
	Tempo (Specifies the metronome tempo.)	20– 120 –250	✓	✓	Page 81
	Beat (Specifies the timing of the metronome's accented beats.)	0–4–7, ♩, ♪, ♫	✓	✓	Page 82
	Level (Specifies the volume of the metronome.)	-6– 0 –6	✓	✓	Page 82
	Monitor (Specifies the output destination for the metronome sound.)	All, Phones			Page 82

Category	Setting (details)	Values	Battery	Playback	Reference page
Key	Key (Changes the playback pitch of the song in semitone steps.)	-12– 0 –12	✓	✓	Page 75
	Pitch (Changes the playback pitch of the song in steps of 1/100th of a semitone.)	-100– 0 –100	✓	✓	Page 76

Category	Setting (details)	Values	Battery	Playback	Reference page
Speed	Speed (Makes the Playback speed slower/faster.)	50– 100 –200	✓	✓	Page 77

Category	Setting (details)	Values	Battery	Playback	Reference page
Center Cancel	Center Cancel (Eliminates the sound heard from the center, such as vocals.)	On1 , On2, On3, Focus1, Focus2	✓	✓	Page 78

About Easy Guide

Easy Guide is a convenient function that lets you operate the CD-2u/SD-2u simply by following the on-screen instructions without having to open the owner's manual.

1 Press the [EASY GUIDE] button.

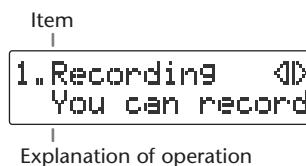
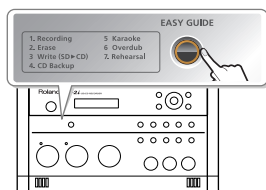

2 Use the [◀] [▶] buttons to select the item for which you want to see an operation guide.

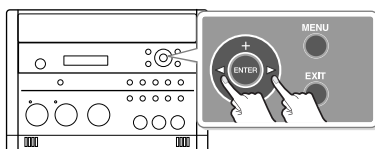

For more about the operations covered by Easy Guide, refer to "Setting Items in Easy Guide" (Page 38).

3 Press the [ENTER] button to confirm your choice.

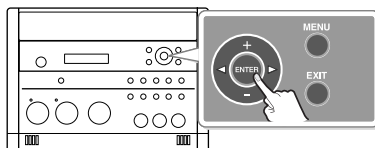

4 Use the [+] [-] buttons to change the value.

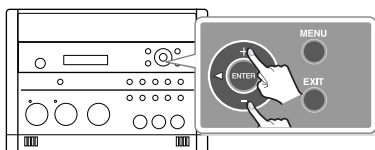

5 Operate the CD-2u/SD-2u as directed by the screen.

If you change your mind during a procedure, press the [EXIT] button.



For details on items that need to be set in the screens appearing in Easy Guide, refer to "Setting Items in Easy Guide" (Page 38).

Setting Items in Easy Guide

This section explains items that you can set in the screens appearing in Easy Guide.

1. Recording

Record a vocal or instrumental performance to either an SD memory card (or a CD-R/RW disc **CD-2u only**).

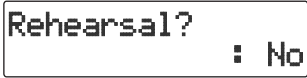
Displayed screen	Explanation
	Select the media to be used for recording. CD-R/RW Choose this if you're recording on a CD-R/RW disc CD-2u only . SD Card Choose this if you're recording on an SD memory card.
	Select what you want to record. Easy INT MIC Choose this if you're making a test recording using the internal mics. * Rehearsal (automatic level setting) will not occur. Acoustic Inst Choose this if you're recording an acoustic instrument (The internal mics will be used.). Vocal Choose this if you're recording a vocal (The external mics will be used.). Digital Piano Choose this if you're recording an electronic musical instrument (The LINE IN (L, R) jacks will be used.). Cassette Tape Choose this if you're recording from a cassette tape or a MD (The LINE IN (L, R) jacks will be used.). Speech Choose this if you're recording a conference (The internal mics will be used.).
	Select the way in which the recording level is to be adjusted. No Adjust the input level manually using the [MIC] knob or [LINE] knob. Yes After a rehearsal, the level will be set to the appropriate level automatically.

2. Erase

Erase a track on either an SD memory card (or a CD-RW disc **CD-2u only**).

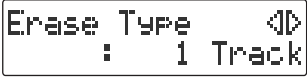
Displayed screen	Explanation
	Select the media that you want to erase. CD-RW Choose this if you're erasing tracks from a CD-R/RW disc CD-2u only . SD Card Choose this if you're erasing tracks from an SD memory card.
	Select how the songs are to be erased. All Tracks All songs will be erased. Last Track The last song on the CD-RW disc will be erased CD-2u only . 1 Track The selected song will be erased. * If you're using an SD memory card, you can choose "All Tracks" or "1 Track." * If you're using a CD-RW disc, you can choose "All Tracks" or "Last Track."

3. Write (SD→CD) **CD-2u**_{only}

Create a music CD by writing tracks from an SD memory card to a CD-R/RW disc.

Displayed screen	Explanation
	<p>Select whether or not the disc is to be finalized once writing is complete.</p> <p>Yes When writing has been completed, the disc will be finalized to complete your music CD.</p> <hr/> <p>No The disc will not be finalized when writing has been completed.</p>

3. Normalize **SD-2u**_{only}

Raise the volume of the entire song as high as possible without causing the sound to distort.

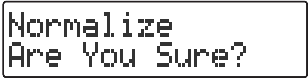

Displayed screen	Explanation
	<p>Select a song.</p>
	<p>If you're sure you want to proceed, press the [ENTER] button. (Note that the process cannot be interrupted once you've started it. If you decide that you don't want to begin the process, press the [EXIT] button.)</p>

4. CD Backup **CD-2u**_{only}

Make a backup of your original music CD.

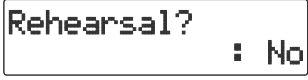

5. Karaoke **CD-2u**_{only}, 4. Karaoke **SD-2u**_{only}

While playing back music, you can add your own vocal, and record the combined result on an SD memory card.

Displayed screen	Explanation
	<p>Select a song.</p>
	<p>Make settings for Center Cancel (Page 78). The setting will turn on/off each time you press the [CENTER CANCEL] button. The "On1" through "On3" settings produce different center cancellation effects. Try each setting, and use the one that is best for your situation.</p>
	<p>Select the way in which the recording level is to be adjusted.</p> <p>No Adjust the input level manually using the [MIC] knob.</p> <hr/> <p>Yes After a rehearsal, the level will be set to the appropriate level automatically.</p>

6. Overdub **CD-2u** only, 5. Overdub **SD-2u** only

While playing back a previously recorded performance from an SD memory card, you can layer (or overdub) another vocal or instrumental performance and record the combined result to a new track.

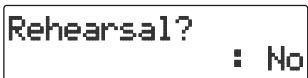
Displayed screen	Explanation
	Select a song.
	Select what you want to record. Easy INT MIC Choose this if you're making a test recording using the internal mics. <hr/> Acoustic Inst Choose this if you're recording an acoustic instrument (e.g., piano, guitar, string instrument, or wind instrument) (The internal mics will be used.). <hr/> Vocal Choose this if you're recording a vocal (The external mics will be used.). <hr/> Digital Piano Choose this if you're recording an electronic musical instrument (e.g., digital piano or synthesizer) (The LINE IN (L, R) jacks will be used.). <hr/> Cassette Tape Choose this if you're recording from a cassette tape or a MD (The LINE IN (L, R) jacks will be used.).
	Select the way in which the recording level is to be adjusted. No Adjust the input level manually using the [MIC] knob or [LINE] knob. <hr/> Yes After a rehearsal, the level will be set to the appropriate level automatically.

7. Rehearsal **CD-2u** only, 6. Rehearsal **SD-2u** only

Automatically sets the optimal input level while you rehearse your performance.

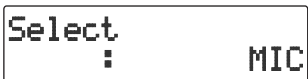
Displayed screen	Explanation
	Specifies which input level is to be adjusted. MIC The MIC input level will be adjusted. <hr/> LINE The LINE input level will be adjusted.

* The input level adjustment made by the rehearsal function will remain in effect until the corresponding input knob is operated or the power is turned off. You'll need to execute the rehearsal function again the next time you turn the power on.

Recording Acoustic Instruments or Vocals

Recording with the Internal Mics

The internal mics are stereo mics. Sound picked up by the mic on the left side of the CD-2u/SD-2u is recorded on the left channel (L), while sound from the mic on the right side is recorded on the right channel (R).

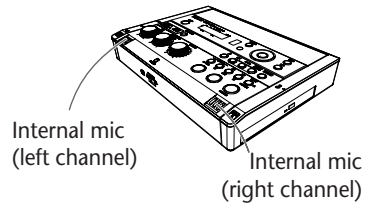

If You're Recording to an SD Memory Card

- 1 Turn on the power (☞ Page 22, 24).
- 2 Insert the SD memory card (☞ Page 26).
- 3 Set the audio source to "SD" **CD-2u only**. Press the [SD CARD] button so it's lit.

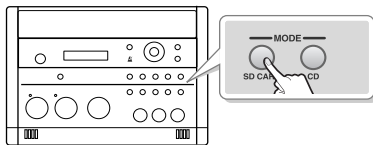

If You're Recording to a **CD-2u only** CD-R/RW Disc

- 1 Turn on the power (☞ Page 22).
- 2 Insert the CD (☞ Page 29).
- 3 Set the audio source to "CD." Press the [CD] button so it's lit.

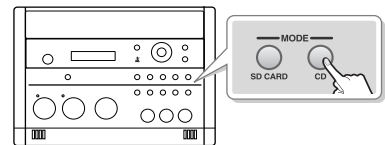

- 4 If you want to listen to the recorded audio while you record, connect headphones to the PHONES jack located on the side of the CD-2u/SD-2u. The sound received by the internal mics will not be heard from the internal speakers. You'll need to use headphones if you want to monitor the sound being recorded. Use the [VOLUME] knob to adjust the headphone volume.

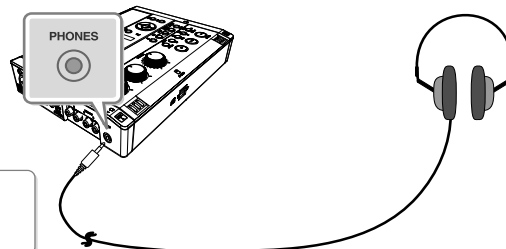

5 Select the internal mics.



① Press the [MENU] button to access the menu screen.

② Use the [<] [>] buttons to choose “MIC Select.”



③ Press the [ENTER] button to confirm your choice.

④ Use the [+] [-] buttons to change the value to select “Internal.”

6 Adjust the input level of the internal mics.

① On the CD-2u/SD-2u's left side, set the [MIC LEVEL] switch to its “MANUAL” position.

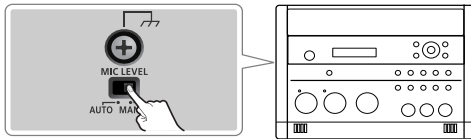

② Turn the [MIC] knob to adjust the input level of the internal mics.

Adjust the loudness of the sound you're recording. Since you're not using the LINE input, turn the [LINE] knob all the way to the left (off).

While producing the sound that you'll actually be recording, turn the [MIC] knob to adjust the input level.

Adjust the level so that the PEAK indicator located above the [MIC] knob lights briefly at the loudest moments of the performance or vocal you'll be recording.

* When using the [MIC] knob or [LINE] knob, you might hear a slight noise when the recording level changes; this does not indicate a malfunction.

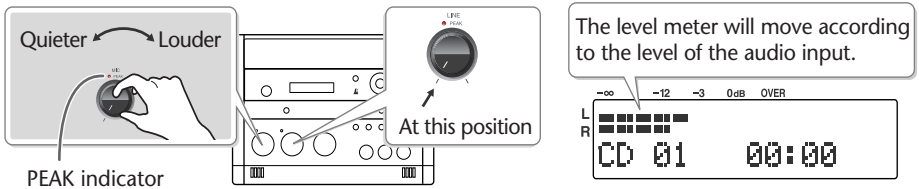

The input level and the recorded result

- **If the input level is high**

There is a limit on the level that the CD-2u/SD-2u is able to record. The PEAK indicator will light to indicate that the audio input has exceeded this limit (i.e., the input is too loud). If you record even though the PEAK indicator is lit, the recorded audio will be distorted.

- **If the input level is too low**

The recorded audio will not be distorted, but the playback will not be as loud as it should be.

7 Press the [●] (Record) button to enter recording-standby mode.

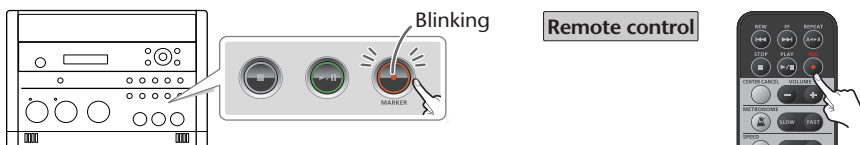

8 Press the [▶/||] (Play) button to begin recording.

Start your performance.

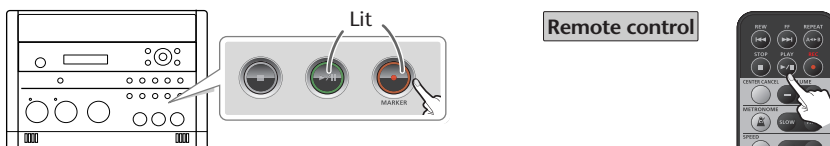

9 Press the [■] (Stop) button to stop recording.



The recorded song will be added to the end of the SD memory card or CD-R/RW disc. If you want to listen to the song you recorded, press the [▶/||] (Play) button immediately after you stop recording.

Important

- Depending on where the CD-2u/SD-2u is positioned in relation to the sound source, the recorded sound may not be evenly distributed between the left and right speakers. In such cases, you can adjust the left/right volume balance of the internal mics and record your performance again. For details, refer to “Adjusting the Left/Right Volume Balance of the Internal Mics” (Page 120).
- When turning the [MIC] knob, you may hear a faint noise when the input level changes, but this is not a malfunction.

Important

CD-2u only

- Since the CD-2u is equipped with highly-sensitive mics, undesired sounds such as the operating noise of the CD-R/RW drive or the sound of buttons being pressed may be recorded inadvertently. If you notice such problems, you can try lowering the input level of the internal mics.
If you're recording to an SD memory card, no CD-R/RW drive operating noise will be recorded.
- If you've finished recording a CD-R/RW disc and would like to play that disc on another CD player, you'll need to execute the “Finalize” operation. You can finalize the CD-R/RW disc when ejecting it. For details, refer to “Making a CD-R/RW Disc for Playback on Another CD Player (Finalize)” (Page 99).

Automatically Setting the Optimal Input Level from Your Rehearsal Performance (Rehearsal Function)

Instead of adjusting the level by manually operating the [MIC] knob or [LINE] knob, you can use this function to have the optimal input level be set automatically while you rehearse the music before the actual performance to be recorded.

“7. Rehearsal **CD-2u** only, 6. Rehearsal **SD-2u** only, (Page 40)

Play the loudest portion in the song.

Adjusting the Input Level Automatically (Auto Level Function)

The Auto Level function can adjust the input level automatically during recording in response to the loudness of the audio signal. Auto Level is particularly suitable for recordings that are mainly of human voices, such as a conference or lecture. Auto Level is not suitable when recording musical performances for which you want to capture the expressive dynamics of the sound. If you're recording music, choose the manual setting or use the rehearsal function to set the input level.

To use the Auto Level function, make the following settings in Step 6- ① on Page 42. In this case, the input level will be adjusted automatically, so you won't need to perform Step 6- ②.

Set the [MIC LEVEL] switch located on the CD-2u/SD-2u's side panel to its "AUTO" (automatic) position.

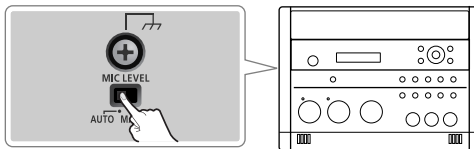

Switch setting	Explanation
MANUAL	Record at the input level determined by the [MIC] knob.
AUTO	Turn on the Auto Level function. The input level will be adjusted automatically. The input level will not change even if you turn the [MIC] knob.

Connecting the External Mics for Recording

Here's how to record using the connected dynamic mics or stereo mic.

- * Dynamic mics are highly durable, and are suitable for recording instruments or vocals. They also have the advantage of not requiring a power supply.
- * This device also supports condenser mics that require a power supply, as well as plug-in power mic. Connect the condenser mics to the XLR type EXT MIC (L, R) jacks, and connect a plug-in power mic to the PLUG IN POWER MIC jack.
- * If you encounter a problem with noise or distortion, see "The recorded sound is noisy or distorted" (Page 127).



If You're Recording to an SD memory Card

- 1 Turn on the power (☞ Page 22, 24).
- 2 Insert the SD memory card (☞ Page 26).
- 3 Set the audio source to "SD" **CD-2u only**. Press the [SD CARD] button so it's lit.

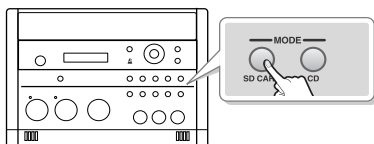

If You're Recording to a CD-R/RW Disc **CD-2u only**

- 1 Turn on the power (☞ Page 22).
- 2 Insert the CD (☞ Page 29).
- 3 Set the audio source to "CD." Press the [CD] button so it's lit.

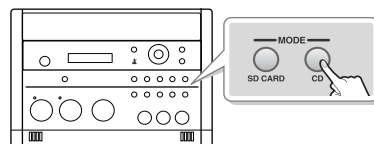

- 4 Connect your mic to the EXT MIC (L, R) jacks or PLUG IN POWER MIC jack located on the CD-2u/SD-2u's side panel.

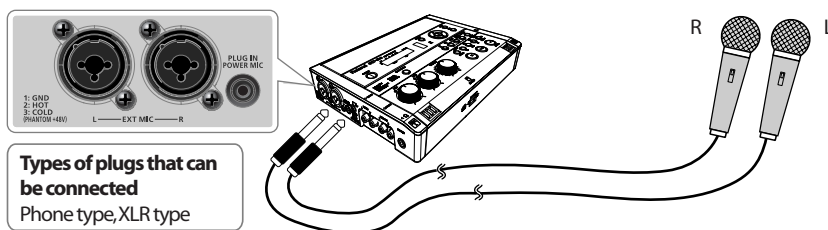

5 Select the External mics.



- ① Press the [MENU] button to access the menu screen.
- ② Use the [<] [>] buttons to choose “MIC Select.”
- ③ Press the [ENTER] button to confirm your choice.
- ④ Use the [+] [-] buttons to choose “External,” “Ext(MONO),” or “Plug-In Power.”

Value	Explanation
External	External mics connected to EXT MIC (L, R) are selected.
Ext(MONO)	External mics connected to EXT MIC (L, R) are selected. Audio from left and right will both be sounded at the center (mono).
Plug-In Power	The plug-in power mic connected to the PLUG IN POWER MIC jack is selected.
Auto	Whenever a plug is connected to an EXT MIC (L, R) jack, the external mics are selected. If no plugs are connected to the EXT MIC (L, R) jacks, the internal mics are selected. However, automatic selection will not occur when a plug is inserted into the PLUG IN POWER MIC jack.

6 Adjust the input level of the external mics.

- ① On the CD-2u/SD-2u's left side, set the [MIC LEVEL] switch to its “MANUAL” position.

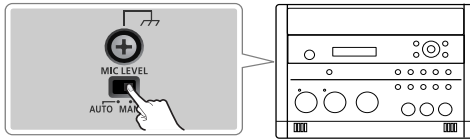

- ② Turn the [MIC] knob to adjust the input level of the external mics.

Adjust the loudness of the sound you're recording. Since you're not using the LINE input, turn the [LINE] knob all the way to the left (off).

While producing the sound that you will actually be recording, turn the [MIC] knob to adjust the input level.

Adjust the level so that the PEAK indicator located above the [MIC] knob lights briefly at the loudest moments of the performance or vocal you'll be recording.

- * When using the [MIC] knob or [LINE] knob, you might hear a slight noise when the recording level changes; this does not indicate a malfunction.

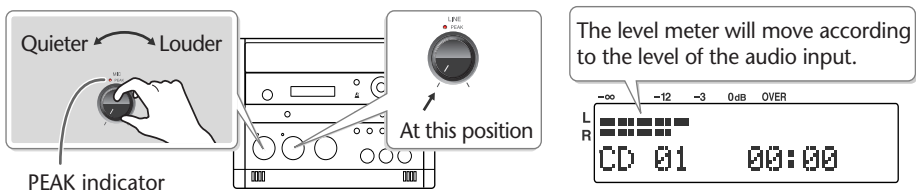

- * If sound from the speakers enters the mic, you won't be able to adjust the level correctly. While adjusting the level, either turn the [VOLUME] knob all the way down or turn the speakers off, so no sound will be produced. Use headphones if you want to monitor the sound that's being recorded

If the sound from the microphone distorted even though you've turned the [MIC] knob down, you can decrease the external mic sensitivity.

At the factory settings, the external mic sensitivity is set to “High.” If the level meter does not move sufficiently, change this setting to “Low.” For details, refer to the text box “Selecting the External Mic Sensitivity” on Page 48.

7 Press the [●] (Record) button to enter recording-standby mode.



8 Press the [▶/||] (Play) button to begin recording.

Start your performance.

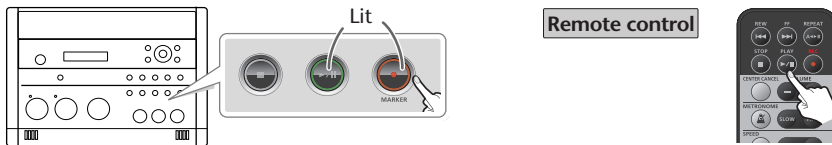

9 Press the [■] (Stop) button to stop recording.



The recorded song will be added to the end of the SD memory card or CD-R/RW disc. If you want to listen to the song you recorded, press the [▶/||] (Play) button immediately after you stop recording.

Important

- Sound will not be produced from the speakers while in recording-standby mode or while recording. If you want to listen to the sound that's being recorded, you'll need to use headphones. (Refer to Step 4 on Page 41.)
- Howling could be produced depending on the location of microphones relative to speakers. This can be remedied by:
 - Changing the orientation of the microphone(s).
 - Relocating microphone(s) at a greater distance from speakers.
 - Lowering volume levels.
- When turning the [MIC] knob, you may hear a faint noise when the input level changes, but this is not a malfunction.

Important

CD-2u only

If you've finished recording a CD-R/RW disc and would like to play that disc on another CD player, you'll need to execute the "Finalize" operation. You can finalize the CD-R/RW disc when ejecting it. For details, refer to "Making a CD-R/RW Disc for Playback on Another CD Player (Finalize)" (Page 99).

Selecting the External Mic Sensitivity

You can set the sensitivity as appropriate for the external mic you're using.

- 1 Press the [MENU] button to access the menu screen, and choose "EXT MIC Sens."



AUDIO
EXT MIC Sens

- ① Press the [MENU] button to access the menu screen.
- ② Use the [<] [>] buttons to choose "EXT MIC Sens."
- ③ Press the [ENTER] button to confirm your choice.

- 2 Use the [+] [-] buttons to change the external mic sensitivity setting.



EXT MIC Sens
:High

Value	Explanation
Low	Lowers the sensitivity of the external mic. If the movement of the level meter does not decrease when you adjust the input level, select the "Low" setting. This is appropriate for a condenser mic.
High (factory setting)	Raises the sensitivity of the external mic. If the movement of the level meter does not increase when you adjust the input level, select the "High" setting. This is appropriate for a dynamic mic.

- 3 Press the [EXIT] button twice.
You're returned to the audio source screen.

Using Phantom Power

The EXT MIC (L, R) jacks can supply 48 V phantom power, allowing you to connect a condenser mic that requires phantom power.

Turn on the phantom power switch if you're using a condenser mic that requires phantom power.

- * Be sure to turn off the phantom power switch unless you've connected a mic that requires phantom power. Supplying phantom power to a dynamic mic or an audio playback device will cause malfunctions. Before use, please check the specifications of the mic you're connecting. (This device's phantom power supply: DC 48 V, 8 mA max.)

1 Press the [MENU] button to access the menu screen, and choose "Phantom Power."



- 1 Press the [MENU] button to access the menu screen.
- 2 Use the [<] [>] buttons to choose "Phantom Power."
- 3 Press the [ENTER] button to confirm your choice.

2 Use the [+] [-] buttons to change the setting to select phantom power.



Value	Explanation
Off	Phantom power will not be supplied.
On	Phantom power will be supplied.

- * It takes several seconds for phantom power to be switched. Please note that during this time, the audio from the mic will be muted so that recording and output will not be possible.
- * The phantom power on/off setting is for both of the EXT MIC (L, R) jacks. This on/off setting cannot be made individually for the two jacks.

3 Press the [EXIT] button twice.

You're returned to the audio source screen.

Recording an Electronic Instrument

Here's how to connect an electronic instrument such as a digital piano or keyboard, and record your performance.

If you're Recording to an SD Memory Card

- 1 Turn on the power (☞ Page 22, 24).
- 2 Insert the SD memory card (☞ Page 26).
- 3 Set the audio source to "SD" **CD-2u only**. Press the [SD CARD] button so it's lit.

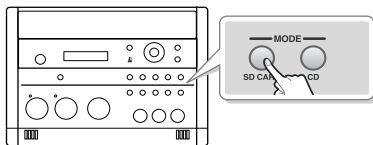

If you're Recording to a **CD-2u only** CD-R/RW Disc

- 1 Turn on the power (☞ Page 22).
- 2 Insert the CD (☞ Page 29).
- 3 Set the audio source to "CD." Press the [CD] button so it's lit.

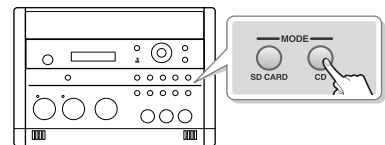

- 4 Connect the CD-2u/SD-2u's LINE IN (L, R) jacks to your electronic instrument (digital piano, keyboard, etc.).

Use audio cables to connect the CD-2u/SD-2u's LINE IN (L, R) jacks to the output jacks of your electronic musical instrument.

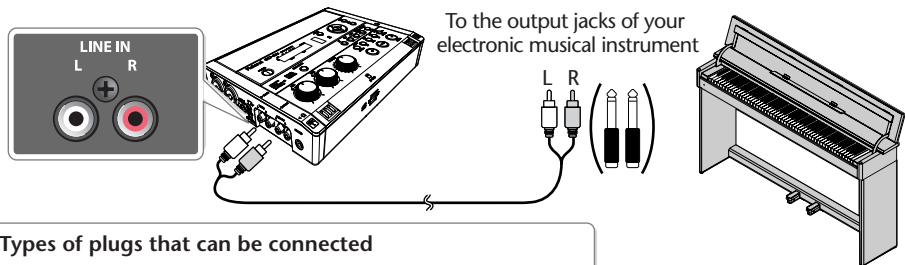

Types of plugs that can be connected
 CD-2u/SD-2u: RCA phono type
 Electronic musical instrument: RCA phono type or phone type

- * Refer to the owner's manual of your electronic musical instrument for the appropriate type of plug to use.

- 5 Turn the [LINE] knob to adjust the input level at the LINE IN (L, R) jacks.

Adjust the loudness of the sound you're recording. Since you're not using the mic input, set the [MIC LEVEL] switch to the "MANUAL" position, and then turn the [MIC] knob all the way to the left (off).

While producing the sound that you will actually be recording, turn the [LINE] knob to adjust the input level.

Adjust the level so that the PEAK indicator located above the [LINE] knob lights briefly at the loudest moments of the performance you'll be recording.

- * When using the [MIC] knob or [LINE] knob, you might hear a slight noise when the recording level changes; this does not indicate a malfunction.

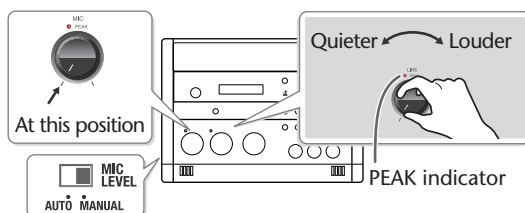

The level meter will move according to the level of the audio input.

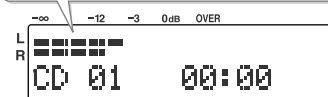

6 Press the [●] (Record) button to enter recording-standby mode.



7 Press the [▶/||] (Play) button to begin recording.

Start your performance.

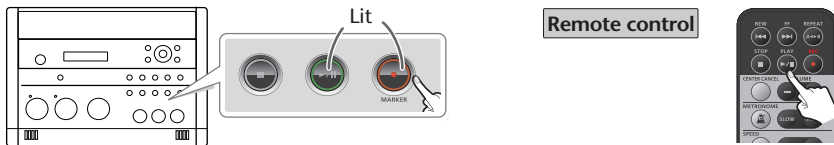

8 Press the [■] (Stop) button to stop recording.



The recorded song will be added to the end of the SD memory card or CD-R/RW disc. If you want to listen to the song you recorded, press the [▶/||] (Play) button immediately after you stop recording.

Important

- Sound will not be produced from the speakers while in recording-standby mode or while recording. If you want to listen to the sound that's being recorded, you'll need to use headphones. (Refer to Step 4 on Page 41.)
- When turning the [LINE] knob, you may hear a faint noise when the input level changes, but this is not a malfunction.
- When connection cables with resistors are used, the volume level of equipment connected to the inputs (EXT MIC (L, R), LINE IN) may be low. If this happens, use connection cables that do not contain resistors.
- If you want to record your performance on an electronic piano together with your voice, make connections as shown in this illustration so that the sound from the mic will also be output from the speakers of the electronic piano.

With this setup, set OUTPUT Select to "MIC" to prevent a feedback loop from occurring between the CD-2u/SD-2u and the electronic piano. For details, refer to "Selecting the Audio Source that's Sent from the LINE OUT Jack" (Page 124).

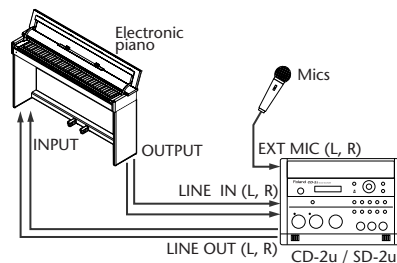

Important

CD-2u only

If you've finished recording a CD-R/RW disc and would like to play that disc on another CD player, you'll need to execute the "Finalize" operation. You can finalize the CD-R/RW disc when ejecting it. For details, refer to "Making a CD-R/RW Disc for Playback on Another CD Player (Finalize)" (Page 99).

Recording a Cassette or Digital Audio Player

Here's how to record the sound from a cassette or Digital Audio Player.

If You're Recording to an SD Memory Card

- 1 Turn on the power (☞ Page 22, 24).
- 2 Insert the SD memory card (☞ Page 26).
- 3 Set the audio source to "SD" **CD-2u only**. Press the [SD CARD] button so it's lit.

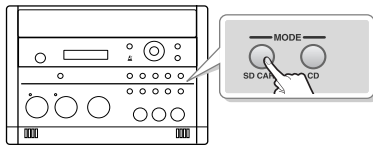

If You're Recording to a **CD-2u only** CD-R/RW Disc

- 1 Turn on the power (☞ Page 22).
- 2 Insert the CD (☞ Page 29).
- 3 Set the audio source to "CD." Press the [CD] button so it's lit.

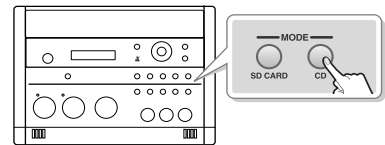

- 4 Connect your audio device (e.g., cassette deck) to the CD-2u/SD-2u's LINE IN (L, R) jacks.

Use audio cables to connect the CD-2u/SD-2u's LINE IN (L, R) jacks to the output jacks of your audio device (e.g., cassette deck).

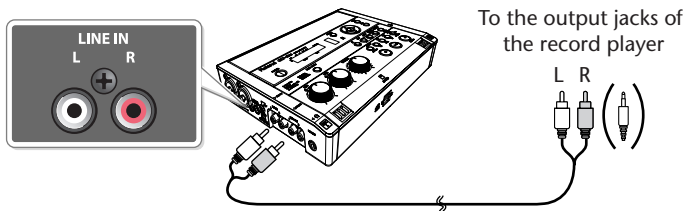

Types of plugs that can be connected
 CD-2u/SD-2u: RCA phono type
 Audio device: RCA phono type
 * Portable players use a stereo mini type jack.

- 5 Turn the [LINE] knob to adjust the input level at the LINE IN (L, R) jacks. Adjust the loudness of the sound you're recording. Since you're not using the mic input, set the [MIC LEVEL] switch to the "MANUAL" position, and then turn the [MIC] knob all the way to the left (off).

While playing the song to be recorded, turn the [LINE] knob to adjust the input level. Adjust the level so that the PEAK indicator located above the [LINE] knob lights briefly during the loudest passages of the song that's being recorded.

After you've adjusted the input level, rewind your playback device to the beginning of the song that you want to record.

- * When using the [MIC] knob or [LINE] knob, you might hear a slight noise when the recording level changes; this does not indicate a malfunction.

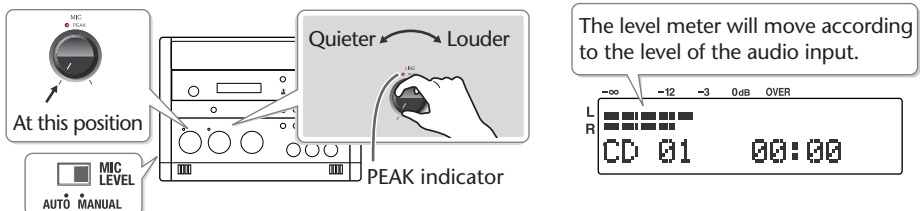

6 Press the [●] (Record) button to enter recording-standby mode.

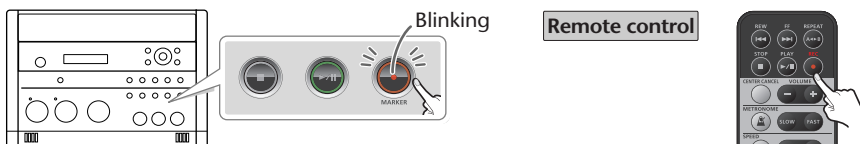

7 Press the [▶/II] (Play) button to begin recording.

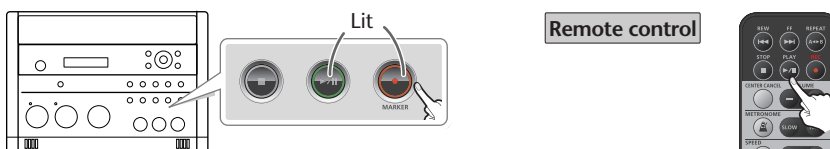

8 Play back your audio device (e.g., cassette deck). The song being played will be recorded.

9 Press the [■] (Stop) button to stop recording.



The recorded song will be added to the end of the SD memory card or CD-R/RW disc. If you want to listen to the song you recorded, press the [▶/II] (Play) button immediately after you stop recording.

Important

- Sound will not be produced from the speakers while in recording-standby mode or while recording. If you want to listen to the sound that's being recorded, you'll need to use headphones. (Refer to Step 4 on Page 41.)
- When turning the [LINE] knob, you may hear a faint noise when the input level changes, but this is not a malfunction.
- When connection cables with resistors are used, the volume level of equipment connected to the inputs (EXT MIC (L, R), LINE IN) may be low. If this happens, use connection cables that do not contain resistors.

Important

CD-2u only

If you've finished recording a CD-R/RW disc and would like to play that disc on another CD player, you'll need to execute the "Finalize" operation. You can finalize the CD-R/RW disc when ejecting it. For details, refer to "Making a CD-R/RW Disc for Playback on Another CD Player (Finalize)" (Page 99).

Recording Karaoke

Here's how the sound of the accompaniment and the sound of your voice being input via a mic can be recorded together to an SD memory card.

As the accompaniment for your recording, you can use the sound being input to the LINE IN (L, R) jacks (e.g., from a digital audio player) (or the sound of a CD **CD-2u only**).

If Using Accompaniment from a CD

CD-2u only

* In order to perform this operation, you'll need the included, dedicated AC adaptor.

- 1 Turn on the power (☞ Page 22).
- 2 Insert the SD memory card for recording (☞ Page 26).
- 3 Connect your mic to the EXT MIC (L, R) jacks or PLUG IN POWER MIC jack located on the CD-2u's side panel.

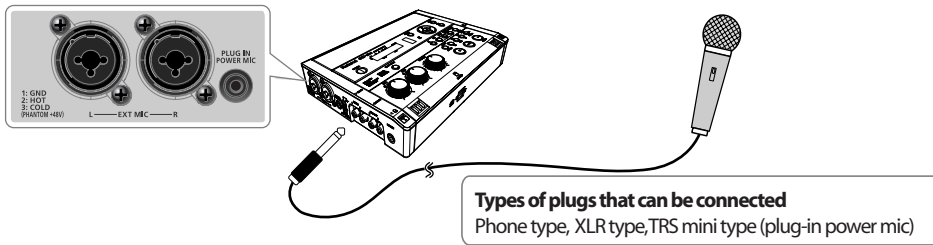

- 4 Select the External mics.



- ① Press the [MENU] button to access the menu screen.
- ② Use the [<] [>] buttons to choose "MIC Select."



- ③ Press the [ENTER] button to confirm your choice.
- ④ Use the [+] [-] buttons to choose "External," "Ext(MONO)," or "Plug-In Power."

- 5 On the CD-2u's left side, set the [MIC LEVEL] switch to its "MANUAL" position.

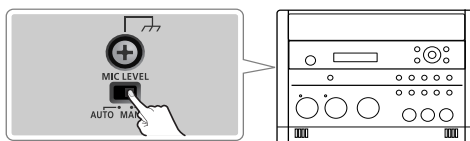

- 6 Prepare your karaoke CD.

- ① Insert the karaoke CD (☞ Page 29).
- ② Press the [CD] button so it's lit, and set the audio source to "CD."

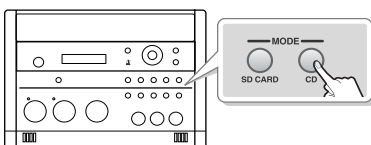

- ③ Use the [<<<] [>>>] buttons to select the song that you want to record.

7 Adjust the CD's playback level.

Adjust the levels to obtain the desired volume balance between the CD and the mic.

- * If sound from the speakers enters the mic, you won't be able to adjust the level correctly. While adjusting the level, either turn the [VOLUME] knob all the way down or turn the speakers off, so no sound will be produced. Use headphones if you want to monitor the sound that's being recorded.

- 1 Press the [▶/||] (Play) button to play back the CD.
- 2 Press the [◀] or [▶] button to access the SD/CD Level setting screen.
- 3 Use the [+] [-] buttons to adjust the CD's playback level ("SD/CD Level").

SD/CD Level : -3

Value (units: dB)	Explanation
-6-0-6	Decreasing this value will lower the playback level. Increasing it will raise the playback level. "0" is the CD's original playback level.

- * If you don't press the [+] [-] buttons for five seconds, you'll automatically be returned to the audio source display.

8 Turn the [MIC] knob to adjust the input level of the external mics.

As a guideline, adjust the level so that the level meter's "-3 dB" indicator lights briefly when audio from the CD is being produced simultaneously with the sound from the mic. When you've finished adjusting the level, press the [■] (Stop) button to stop the CD playback.

- * When using the [MIC] knob or [LINE] knob, you might hear a slight noise when the recording level changes; this does not indicate a malfunction.

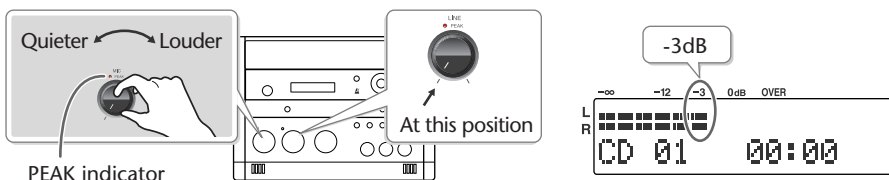

9 Press the [MENU] button to access the menu screen, and choose "Overdub CD→SD?" CD-2u only

- 1 Press the [MENU] button to access the menu screen.
- 2 Use the [◀] [▶] buttons to choose "Overdub CD→SD?"

SD CARD ◀▶
Overdub CD→SD?

- 3 Press the [ENTER] button to confirm your choice.

The CD-2u/SD-2u will be in recording-standby mode.

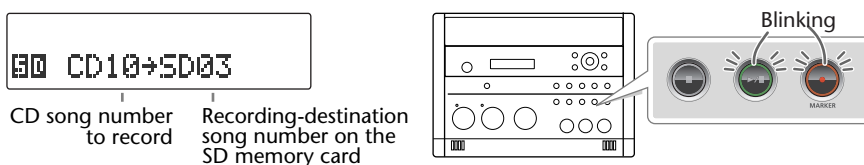

10 Press the [▶/||] (Play) button to begin recording.

The song begins playing, and recording on the SD memory card begins simultaneously. Record your vocal or instrumental performance.

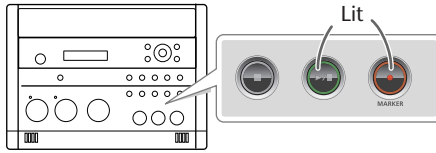

During recording, the upper right of the screen will show "CD → SD."



Remote control



When song stops, recording will also end automatically. If you want to stop recording in the middle of the song, press the [■] (Stop) button.

The recorded song will be added to the end of the SD memory card. If you want to listen to the song you recorded, press the [▶/||] (Play) button immediately after you stop recording.

If Using Accompaniment from a Cassette or Digital Audio Player (LINE Input)

If You're Recording to an SD Memory Card

- 1 Turn on the power (☞ Page 22, 24).
- 2 Insert the SD memory card (☞ Page 26).
- 3 Set the audio source to "SD" **CD-2u only**. Press the [SD CARD] button so it's lit.

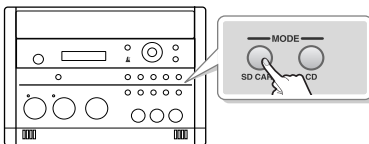

If You're Recording to a **CD-2u only** CD-R/RW Disc

- 1 Turn on the power (☞ Page 22).
- 2 Insert the CD (☞ Page 29).
- 3 Set the audio source to "CD." Press the [CD] button so it's lit.

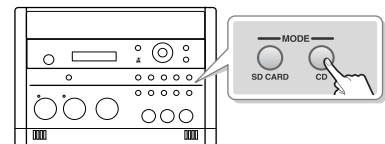

4 Connect your audio device (e.g., cassette deck) to the CD-2u/SD-2u's LINE IN (L, R) jacks.

Use audio cables to connect the CD-2u/SD-2u's LINE IN (L, R) jacks to the output jacks of your audio device (e.g., cassette deck).

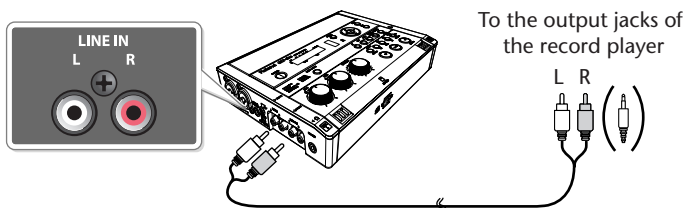

Types of plugs that can be connected

CD-2u/SD-2u: RCA phono type

Audio device: RCA phono type

* Portable players use a stereo mini type jack.

- 5** Connect your mic to the EXT MIC (L, R) jacks or PLUG IN POWER MIC jack located on the CD-2u/SD-2u's side panel.

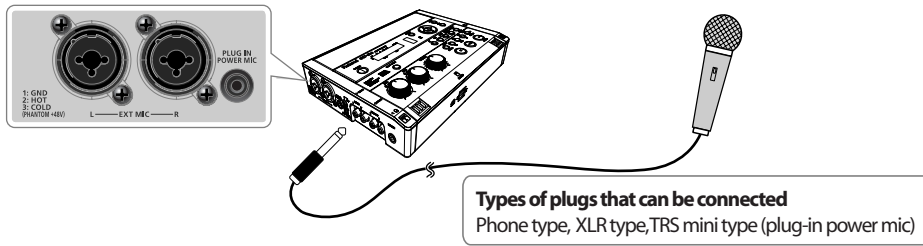

- 6** Select the External mics.



- ① Press the [MENU] button to access the menu screen.
- ② Use the [<] [>] buttons to choose "MIC Select."
- ③ Press the [ENTER] button to confirm your choice.
- ④ Use the [+] [-] buttons to choose "External," "Ext(MONO)," or "Plug-In Power."

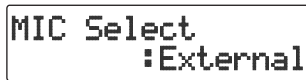

- 7** On the CD-2u/SD-2u's left side, set the [MIC LEVEL] switch to its "MANUAL" position.

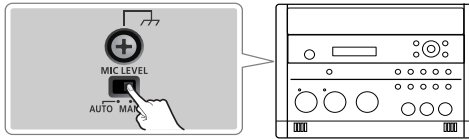

- 8** Turn the [LINE] knob to adjust the input level at the LINE IN jacks.

Adjust the loudness of the sound you're recording.

While playing the song to be recorded, turn the [LINE] knob to adjust the input level. Adjust the level so that the PEAK indicator located above the [LINE] knob lights briefly during the loudest passages of the song that's being recorded.

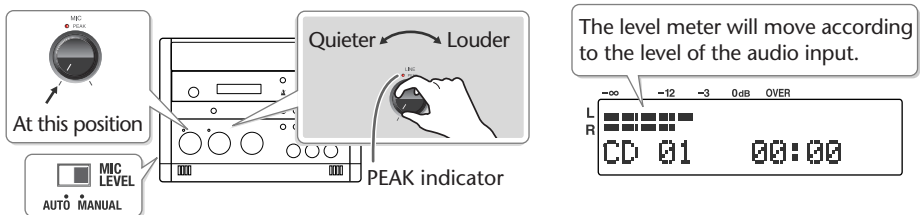

- 9** Turn the [MIC] knob to adjust the input level of the external mics.

As a guideline, adjust the level so that the level meter's "-3 dB" indicator lights briefly when audio from the connected audio device is being produced simultaneously with the sound from the mic.

After you've adjusted the input level, rewind your playback device to the beginning of the song that you want to record.

- * When using the [MIC] knob or [LINE] knob, you might hear a slight noise when the recording level changes; this does not indicate a malfunction.

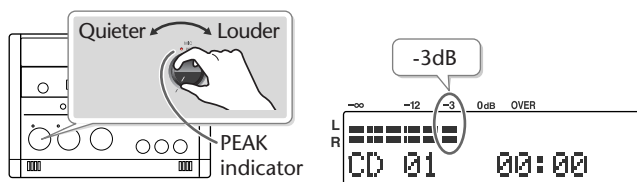

10 Press the [●] (Record) button to enter recording-standby mode.



11 Press the [▶/II] (Play) button to begin recording.

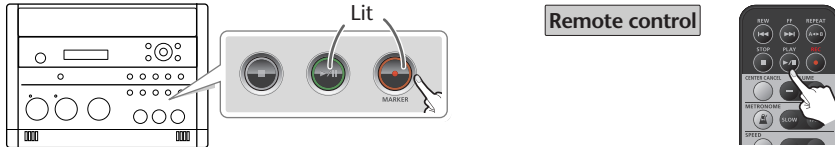

12 Play back your audio device (e.g., cassette deck). The song being played will be recorded.

13 Press the [■] (Stop) button to stop recording.



The recorded song will be added to the end of the SD memory card or CD-R/RW disc. If you want to listen to the song you recorded, press the [▶/II] (Play) button immediately after you stop recording.

Important

- "Key" (Page 75), "Pitch" (Page 76), and "Speed" (Page 77) settings will automatically revert to the values of the original song only during recording. When recording ends, these settings will return to the values you specified.
- Sound will not be produced from the speakers while in recording-standby mode or while recording. If you want to listen to the sound that's being recorded, you'll need to use headphones. (Refer to Step 4 on Page 41.)
- Howling could be produced depending on the location of microphones relative to speakers. This can be remedied by:
 1. Changing the orientation of the microphone(s).
 2. Relocating microphone(s) at a greater distance from speakers.
 3. Lowering volume levels.
- When turning the [MIC] knob, you may hear a faint noise when the input level changes, but this is not a malfunction.
- The playback level ("SD/CD Level") setting (Page 55) is common to the CD and the SD memory card. When you turn off the power, this setting will return to "0."

Layering Your Performance onto an SD Memory Card Song and Recording It

Here's how you can play back a recorded performance from an SD memory card, add a vocal or a performance of another instrument, and re-record the combined result onto the SD memory card (overdubbing a vocal or other performance onto an SD memory card song). Since you can perform and overdub each part separately, this allows you to record your piano performance, and then sing along to add a vocal to your performance.

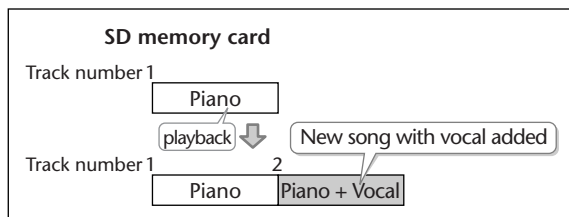

All audio received via the external mics, internal mics, and LINE IN (L,R) jacks can be overdubbed with a song on the SD memory card. Make settings as appropriate for your instruments and your setup.

- 1 Turn on the power (☞ Page 22, 24).
- 2 Insert the SD memory card (☞ Page 26).
- 3 Make preparations for recording.

If you're using the internal mics	☞ Make preparations as described in Steps 5 on Page 41.
If you're using the external mics	☞ Make preparations as described in Steps 4–5 on Page 45.
If you're using the LINE inputs	☞ Make preparations as described in Steps 4–5 on Page 50.

4 Prepare your SD memory card.

- ① Press the [SD CARD] button so it's lit, and set the audio source to "SD" **CD-2u** only.

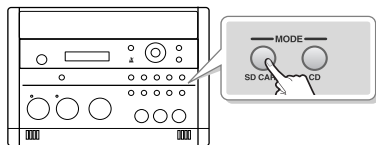

- ② Use the [◀◀] [▶▶] buttons to select the song that you want to record.

5 Adjust the playback level of the SD memory card and the input level of the audio input.

Adjust each level to obtain the appropriate volume balance between the SD memory card audio and the audio input.

- ① Press the [▶/II] (Play) button to play back the SD memory card.
- ② Press the [◀] or [▶] button to access the SD/CD Level or SD Level setting screen.
- ③ Use the [+] [-] buttons to adjust the SD memory card's playback level ("SD/CD Level" or SD Level").



* If you don't press the [+] [-] buttons for five seconds, you'll automatically be returned to the audio source display.

Value (units: dB)	Explanation
-6-0 (factory setting)-6	Decreasing this value will lower the playback level. Increasing it will raise the playback level. "0" is the playback level of the original song.

- ④ Adjust the input level of the audio input.

Adjust the levels so that the level meter briefly reaches the "-3 dB" indicator when the audio from the SD memory card and the audio from the external source are being input simultaneously.

When you've finished adjusting the level, press the [■] (Stop) button to stop the SD memory card playback.

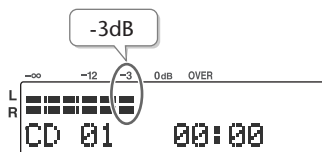

Using the internal mics

☞ Make adjustments as described in Step 6 of Page 42.

Using the external mics

☞ Make adjustments as described in Step 6 of Page 46.

Using the LINE inputs

☞ Make adjustments as described in Step 6 of Page 50.

6 Press the [MENU] button to access the menu screen, and choose "Overdub SD→SD?"

- ① Press the [MENU] button to access the menu screen.
- ② Use the [◀] [▶] buttons to choose "Overdub SD→SD?"

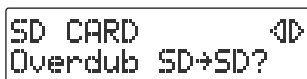

- ③ Press the [ENTER] button to confirm your choice.

The CD-2u/SD-2u will be in recording-standby mode.

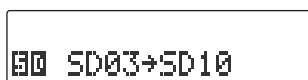

Song to record Recording-destination song number

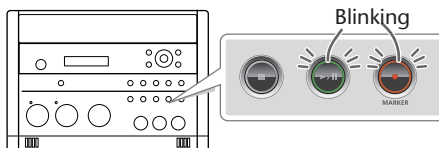

7 Press the [▶/II] (Play) button to begin recording.

When the SD memory card song you selected in Step 4- ② begins playing, recording on the SD memory card will begin simultaneously. Start your performance.

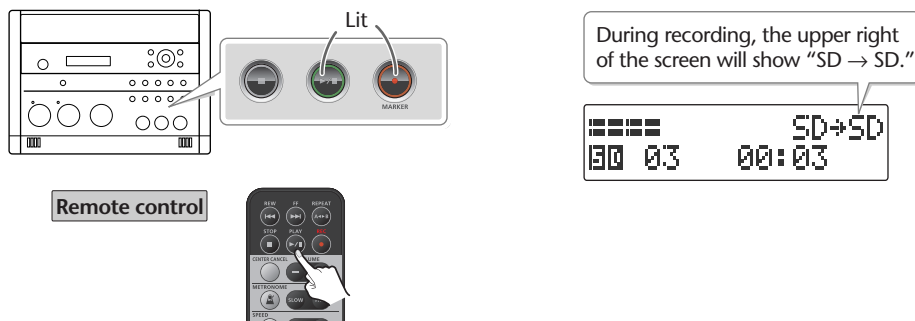

8 Press the [■] (Stop) button to stop recording.

The recorded song will be added to the end of the SD memory card. If you want to listen to the song you recorded, press the [▶/II] (Play) button immediately after you stop recording.



Important

- “Key” (Page 75), “Pitch” (Page 76), and “Speed” (Page 77) settings will automatically revert to the values of the original song only during recording. When recording ends, these settings will return to the values you specified.
- Sound will not be produced from the speakers while in recording-standby mode or while recording. If you want to listen to the sound that’s being recorded, you’ll need to use headphones. (Refer to Step 4 on Page 41.)
- The playback level (“SD/CD Level”) setting is common to the CD and the SD memory card. When you turn off the power, this setting will return to “0.”
- If you decide to stop recording midway through the track, press the [■] (Stop) button.

Convenient Functions for Recording

Automatically Starting Recording When Audio is Detected

When the CD-2u/SD-2u is in recording-standby mode and it detects audio input that exceeds the specified level, recording will start automatically.

- 1 Press the [MENU] button to access the menu screen, and choose "Auto Rec Start."



- ① Press the [MENU] button to access the menu screen.
- ② Use the [<] [>] buttons to choose "Auto Rec Start."
- ③ Press the [ENTER] button to confirm your choice.

- 2 Use the [+] [-] buttons to change the value that specifies the level at which recording will begin automatically.

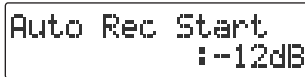

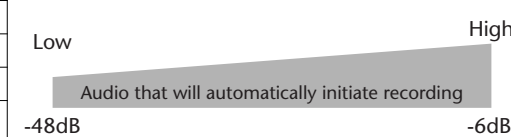
Value	Explanation
Off (factory setting)	Recording will start when you press [▶/II] (Play) during recording standby.
-48dB	
-36dB	
-24dB	
-12dB	
-6dB	

When you're setting the input level, it's a good idea to check how the level meter moves at the beginning of the performance. To avoid losing any of the beginning of your performance, set this trigger level lower than the level at which the performance begins.

- 3 Press the [EXIT] button twice.

You're returned to the audio source screen.

This completes preparations for automatically initiating recording.

When you make settings for automatic recording, the procedure for starting to record will be as follows.

1 Press the [●] (Record) button.

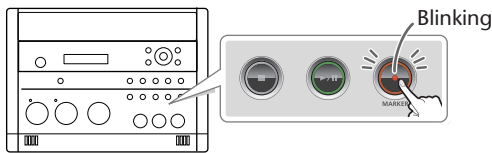

2 Press the [▶/II] (Play) button.

The CD-2u/SD-2u will be in recording-standby mode.

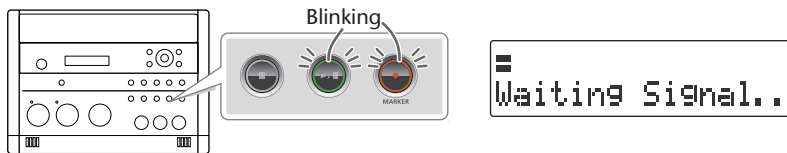

3 Start performing.

When the CD-2u/SD-2u detects audio, recording will begin automatically.

- * In order to avoid losing any audio at the beginning of the performance, recording will actually begin up to 0.5 seconds earlier than the point at which audio exceeding the specified level is detected.

4 Press the [■] (Stop) button to stop recording.

The recorded song will be added to the SD memory card or to the end of the CD-R/RW disc.

Important

- Recording will pause when you press the [▶/II] (Play) button. When audio is detected once again, recording will begin automatically. The point at which recording is resumed will be the next song.
- Automatic recording will not work if you've specified a count-in (Page 68).

Assigning Song Numbers While Recording (Marker)

During recording, you can assign a song number so that the subsequent material will be recorded as the next song. You can assign song numbers in the following three ways.

Assigning song numbers	Reference page
① Press the [●] (Record) button to assign the song number	This page
② Automatically assign song numbers at fixed intervals	Page 65
③ Assign track numbers when silence is detected	Page 66

Important

- You can't delete a track number once it's been assigned.
- You can assign track numbers only during recording.
- You can't assign a new track number less than four seconds after assigning the previous track number.
- You can assign up to 98 track numbers (99 tracks).

Important

CD-2u only

- When you assign a track number to a CD-R/RW disc, two seconds of silence is automatically inserted in front of the new track number.

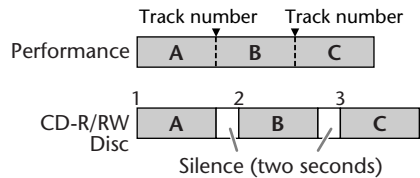

- If you're assigning song numbers to a CD-R/RW disc, you can't assign a new song number while the message at right is displayed.
- Recording will continue even while this message is displayed.

CD REC MARKER
Processing... Ⓢ

Press the [●] (Record) Button to Assign a Song Number

This lets you assign a song number whenever you like during recording. If several songs are being recorded in succession, such as during a live performance, you can assign a track number to each song while you continue recording.

- At the point where you want to assign a track number during recording, press the [●] (Record) button.**

The track number is incremented, and the material that follows will be recorded on the new track.

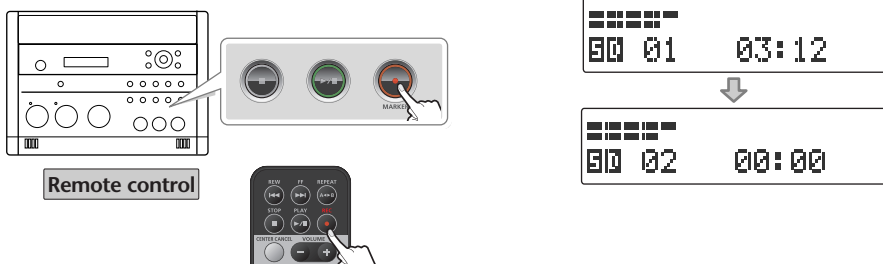

Automatically Assigning a Song Number at Fixed Intervals

When making a long recording such as a lecture, you can automatically assign track numbers at fixed time intervals to divide the recording into tracks. If you've assigned track numbers, it will be easier to find a desired location in the recording.

1 Specify how the song numbers will be assigned.

```
RECORDING  <>
Auto Marker
```

```
Auto Marker
: Time
```

- ① Press the [MENU] button to access the menu screen.
- ② Use the [<] [>] buttons to choose "Auto Marker."
- ③ Press the [ENTER] button to confirm your choice.
- ④ Use the [+] [-] buttons to specify the desired "Time."

Value	Explanation
Off	Song numbers will not be assigned automatically.
Time	Song numbers will be automatically assigned at the specified interval (units of minutes) during recording.
Level	Song numbers will be automatically assigned when silence is detected during recording.

2 Specify the time interval at which song numbers will be assigned.

```
RECORDING  <>
Auto Marker Time
```

```
Auto Marker Time
: 5min
```

- ① Press the [EXIT] button to return to the menu screen.
- ② Use the [<] [>] buttons to choose "Auto Marker Time."
- ③ Press the [ENTER] button to confirm your choice.
- ④ Use the [+] [-] buttons to change the value to the interval of time at which you want to assign song numbers.

Value (units: Minutes)	Explanation
2 minutes (factory setting)–15 minutes	Specifies the time interval (minutes) at which song numbers will be assigned.

3 Press the [EXIT] button twice.

You're returned to the audio source screen.

Subsequently, when you begin recording, track numbers will automatically be assigned at every time interval you've specified in Step 2.

To defeat this setting, choose "Off" in Step 1.

Assigning Track Numbers When Silence is Detected

If a period of silence lasting longer than one second is detected during recording, recording will automatically pause. Then, when audio exceeding the specified level is subsequently detected, a song number will be assigned and recording will automatically resume.

This function is convenient when you're recording songs from a cassette tape or a MD, since the songs will automatically be divided at regions of silence.

1 Specify how the song numbers will be assigned.

```
RECORDING  ◀▶
Auto Marker
```

```
Auto Marker
#Level
```

- ① Press the [MENU] button to access the menu screen.
- ② Use the [<] [>] buttons to choose "Auto Marker."
- ③ Press the [ENTER] button to confirm your choice.
- ④ Use the [+] [-] buttons to specify the desired "Level."

Value	Explanation
Off	Song numbers will not be assigned automatically.
Time	Song numbers will be automatically assigned at the specified interval (units of minutes) during recording.
Level	Song numbers will be automatically assigned when silence is detected during recording.

2 Specify the audio level that will be considered to be silence.

```
RECORDING  ◀▶
Auto Marker Lvl
```

```
Auto Marker Lvl
#-30dB
```

- ① Press the [EXIT] button to return to the menu screen.
- ② Use the [<] [>] buttons to choose "Auto Marker Lvl."
- ③ Press the [ENTER] button to confirm your choice.
- ④ Use the [+] [-] buttons to specify the audio level that will be considered to be silence.

Value	Explanation
-60dB (factory setting)	Audio below the specified level will be considered to be silence.
-54dB	
-48dB	
-42dB	
-36dB	
-30dB	
-24dB	

3 Press the [EXIT] button twice.

You're returned to the audio source screen.

Now when you start recording, and a region of audio below the level specified in Step 2 continues for longer than one second, the next song number will be assigned automatically.

To defeat this setting, choose "Off" in Step 1.

Preventing Loud Sounds from Distorting (Limiter)

This function automatically adjusts the input level so that the audio will not distort even when unexpectedly loud sounds are received while recording.

- 1 Press the [MENU] button to access the menu screen, and choose "Limiter."



- ① Press the [MENU] button to access the menu screen.
- ② Use the [<] [>] buttons to choose "Limiter."
- ③ Press the [ENTER] button to confirm your choice.

- 2 Use the [+] [-] buttons to turn the limiter on/off.



Value	Explanation
Off (factory setting)	The limiter is off.
On	The limiter is on.

- 3 Press the [EXIT] button twice.

You're returned to the audio source screen.

Important

You can't use the limiter function with the LINE input. Using the [LINE] knob, adjust the input until it's at an appropriate level.

Inserting a Count Before Recording Begins (Count-in)

You can sound a count before recording begins. Hearing a count can help you practice the timing or tempo of your performance before you actually start recording.

- 1 Press the [] (Metronome) button to turn on the metronome.

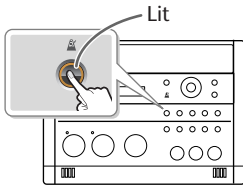

- 2 Specify the sound, tempo, and time signature of the count.

The sound, tempo, and time signature of the count will be the same as specified by the metronome settings. For details, refer to Steps 2–4 of “Sounding the Metronome” (Page 81).

- 3 Press the [MENU] button to access the menu screen, and choose “Count-in (Beat).”

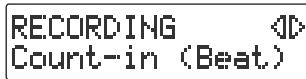

- ① Press the [MENU] button to access the menu screen.
- ② Use the [<] [>] buttons to choose “Count-in (Beat).”
- ③ Press the [ENTER] button to confirm your choice.

- 4 Use the [+] [-] buttons to adjust the value that specifies how many count notes will be sounded before recording begins.

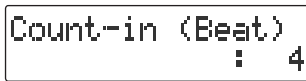

Value	Explanation
Off (factory setting)	No count-in will sound.
1–16	The specified number of count-in beats will sound.

- 5 Press the [EXIT] button twice.

You’re returned to the audio source screen.

If you've specified a count-in, the procedure for starting to record will be as follows.

1 Press the [●] (Record) button.

The CD-2u/SD-2u will be in recording-standby mode.

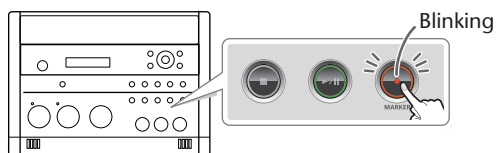

2 Press the [▶/II] (Play) button.

The specified number of counts will be sounded, and then recording will begin.

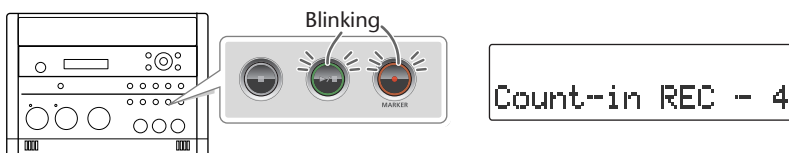

* The metronome will continue sounding even after recording begins.

Listening to a CD/Listening to an SD Memory Card

* In order to play a CD, you'll need to use the dedicated AC adaptor, which was included with the CD-2u/SD-2u.

Listening to a CD

CD-2u only

- 1 Turn on the power (☞ Page 22).
- 2 Insert the CD (☞ Page 29)
- 3 Set the audio source to "CD."
Press the [CD] button so it's lit.

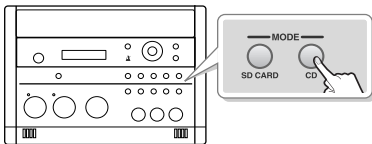

Listening to an SD memory Card

- 1 Turn on the power (☞ Page 22, 24).
- 2 Insert the SD memory card (☞ Page 26).
- 3 Set the audio source to "SD" **CD-2u only**.
Press the [SD CARD] button so it's lit.

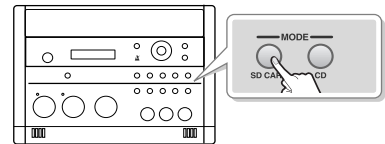

- 4 Press the [▶/||] (Play) button to start playback.

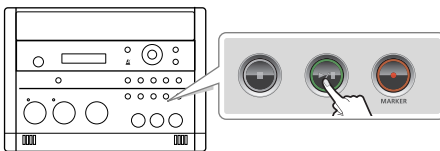

Source name Currently playing track number Elapsed playback time

- 5 Turn the [VOLUME] knob to adjust the volume.

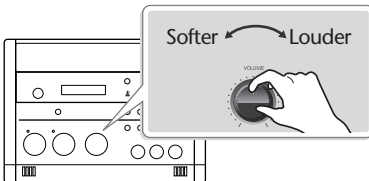

If you don't need the mic or LINE input, you should turn down the input level to the minimum position.

Mic input Set the [MIC LEVEL] switch to the "MANUAL" position, and turn the [MIC] knob all the way to the left (off).

LINE input Turn the [LINE] knob all the way to the left (off).

To do this	Perform this action
Stop playback	Press the [■] (Stop) button. If you press this button while stopped, you will return to the first track.
Pause playback	Press the [▶/] (Play) button. Press it once again to resume playback from the point at which you paused.
Go to the beginning of a track (Skip)	Press the [◀◀] button. Each time you press this button, you go back by one track. If you press this button during playback, you will return to the beginning of the track that was playing. Press the [▶▶] button. Each time you press this button, you advance to the next track.
Skip between songs at high-speed	While stopped, press and hold the [◀◀] or [▶▶] button.
Rewind/fast-forward (Search)	During playback, press and hold. [◀◀] button: Rewind. [▶▶] button: Fast-forward.
High-speed rewind/fast-forward	While paused, press and hold the [◀◀] or [▶▶] button.

Remote operations



Song cue, rewind/fast-forward



Song stop/play (pause)

Adjusting the volume



Higher volume.



Lower volume.

Note

The [VOLUME] knob of the CD-2u/SD-2u itself does not move when you use the remote control to adjust the volume. This will mean that the position of the [VOLUME] knob may not match the actual volume.

Continuing Playback from When You Stopped a Song (Resume Function)

If you press the [■] (Stop) button during playback, the CD-2u/SD-2u can remember the position at which you paused, and will resume playback from that location the next time you start playback. This is called the Resume function.

- 1 Press the [MENU] button to access the menu screen, and choose "Resume."



- 1 Press the [MENU] button to access the menu screen.
- 2 Use the [<] [>] buttons to choose "Resume."
- 3 Press the [ENTER] button to confirm your choice.

- 2 Use the [+] [-] buttons to turn the Resume function on/off.

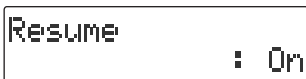

Value	Explanation
Off (factory setting)	The Resume function will be off.
On	The Resume function will be on. The CD-2u/SD-2u will remember the position at which playback was stopped.

- 3 Press the [EXIT] button twice.
You're returned to the audio source screen.

Operation When Resume is On

After pressing the [■] (Stop) button to halt playback, you can press the [▶/||] (Play) button to re-start playback from the location at which you stopped.

If after pressing the [■] (Stop) button to stop playback, you then press the [■] (Stop) button or eject the SD memory card or CD, the Resume function, which had remembered the location at which you stopped, will be cancelled.

Convenient Functions for Playback

Adjusting the Tone (Bass/Treble)

Here's how to adjust the tone of the playback sound to your taste.

- 1** Press the [MENU] button to access the menu screen, and choose "Bass" or "Treble."



- ① Press the [MENU] button to access the menu screen.
- ② Use the [<] [>] buttons to choose "Bass" or "Treble."
- ③ Press the [ENTER] button to confirm your choice.

- 2** Use the [+] [-] buttons to change the tone setting.



Value	Explanation
Bass: -10-0 (factory setting)-10	Adjusts the tone of the low-frequency range.
Treble: -10-0 (factory setting)-10	Adjusts the tone of the high-frequency range.

- 3** Press the [EXIT] button twice.
You're returned to the audio source screen.

Adding Reverberation (Reverb)

This function adds reverberation (reverb) to the audio played back from an SD memory card (or CD **CD-2u only**), creating the impression that the performance is occurring in a concert hall or other real-world acoustic environment.

- 1 **CD-2u only** Press the [MENU] button to access the menu screen, and choose "Reverb."



PLAYBACK
Reverb

- ① Press the [MENU] button to access the menu screen.
- ② Use the [<] [>] buttons to choose "Reverb."
- ③ Press the [ENTER] button to confirm your choice.

- 1 **SD-2u only** Press the [REVERB] button so it's lit.

- 2 Use the [+] [-] buttons to adjust the reverb depth.

Play back from the SD memory card or CD, and check the reverb depth.



Reverb : Off

Value	Explanation
Off CD-2u only	No reverb
Light (factory setting)	Reverb depth: minimum
Medium	Reverb depth: normal
Deep	Reverb depth: maximum

- 3 Press the [EXIT] button.

You're returned to the audio source screen.

Important

Reverb is not added to sound from an external input source such as the built-in mic or the external mics.

Muting the Sound of the Speakers

If you don't want sound to come from the speakers, press the [SPEAKER] button to turn them off. The speakers can be turned back on by pressing the button once again.

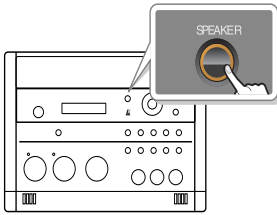

Important

When using the internal mics, you won't hear any sound from the speakers when you're recording or are in recording-standby mode, even if you press the [SPEAKER] button to turn them on (get them to produce sound). This is to prevent the internal mics (or the external microphones) from picking up the sound emanating from the speakers, which would then become part of your recordings.

When using the external microphones, you should turn the speakers on or off as necessary depending on the circumstances.

Exchanging the Left and Right Audio Channels for Playback

The recorded song will play back with the left and right audio channels exchanged. This can be used to conveniently place the recorded audio at a location that is convenient for the listener.

For more about left and right panning, refer to the illustration on Page 121.

* The audio heard from the speakers will not be exchanged.

- 1 Press the [MENU] button to access the menu screen, and choose "OUTPUT Exchange."



① Press the [MENU] button to access the menu screen.

② Use the [<] [>] buttons to choose "OUTPUT Exchange."

③ Press the [ENTER] button to confirm your choice.

- 2 Use the [+] [-] buttons to turn the output exchange on/off.

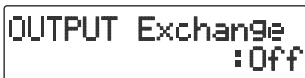

Value	Explanation
Off (factory setting)	You'll hear the sound just as during recording.
On	The left and right audio channels will be exchanged relative to the recording.

- 3 Press the [EXIT] button twice.

You're returned to the audio source screen.

Changing the Key of the Playback

This adjusts the key (pitch) of the playback sound in semitone steps. This can be useful in situations like the following.

- You want to shift the key of an accompaniment that was created for alto sax, so that you can practice flute along with it.
- You want to sing along with a karaoke at a key that's easier for you to sing.

1 Press the [KEY] button to access the menu screen, and choose "Key."

The setting will turn on/off each time you press the [KEY] button.

- * Whenever the unit has remained inactive for a predetermined amount of time, it will go back to displaying the Source (Sound Source) screen.



① Press the [KEY] button to access the menu screen.

② Use the [<] buttons to choose "Key."

2 Use the [+] [-] buttons to adjust the value, changing the key.

If you press the [ENTER] button, the value will return to "0."



- * If you change the key setting during playback, the audio will be interrupted momentarily.

Value	Explanation
-12-0 (factory setting)-12	Decreasing the value by one will lower the overall pitch of the song by a semitone. Increasing the value by one will raise the overall pitch of the song by a semitone. A setting of "0" is the original key of the song. However if this is set to -12, you won't be able to lower the Pitch setting (Page 76) any further. If this is set to 12, you won't be able to raise the Pitch any further.

3 Press the [EXIT] button.

You're returned to the audio source screen.

When you turn off the power, the Key setting will return to "Off."

Remote operations



- UP Raises the key of the playback sound.
- DOWN Lowers the key of the playback sound.
- ON/OFF Turns the key setting on/off.

Making Fine Adjustments to the Playback Pitch (Pitch)

This adjusts the pitch of the playback sound in one-cent steps. One cent is 1/100th of a semitone.

Sometimes when you are practicing your instrument along with a CD, you may have difficulty because the CD playback is pitched slightly different than your instrument. In such cases, you can adjust the CD playback pitch to match your instrument.

When you're using an instrument that is not easily tuned, such as an acoustic piano, you can adjust the pitch of the CD so that it matches your instrument.

1 Press the [KEY] button to access the menu screen, and choose "Pitch."

The setting will turn on/off each time you press the [KEY] button.

- * Whenever the unit has remained inactive for a predetermined amount of time, it will go back to displaying the Source (Sound Source) screen.

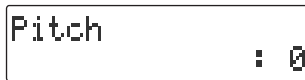

① Press the [KEY] button to access the menu screen.

② Use the [>] buttons to choose "Pitch."

2 Use the [+] [-] button to adjust the Pitch setting.

If you press the [ENTER] button, the value will return to "0."



- * If you change the pitch setting during playback, the audio will be interrupted momentarily.

Value (units: Cents)	Explanation
-100-0 (factory setting)-100	Lowering the value will lower the overall pitch of the song. Raising the value will raise the overall pitch of the song. A setting of "0" is the original pitch of the song. However if Key (Page 75) is set to -12, you won't be able to set the Pitch to a negative (-) value. If Key is set to 12, you won't be able to set the Pitch to a positive (+) value.

If you have a CD that was recorded at a reference pitch of A=440 Hz, and you want to play it back at a reference pitch of A=442 Hz, you would set Pitch to "8."

Refer to the table at right.

Frequency of A4 after adjustment	Pitch setting
438Hz	-8 (cents)
439Hz	-4 (cents)
440Hz	0
441Hz	4 (cents)
442Hz	8 (cents)

3 Press the [EXIT] button.

You're returned to the audio source screen.

When you turn off the power, the Key setting will return to "Off."

Slowing Down or Speeding Up Playback

You can make the playback speed slower or faster. You can also change the playback speed without affecting the pitch.

This is useful when you are learning a song by ear and want to hear it slowly, or if you want to quickly listen to a song that you recorded.

1 Press the [SPEED] button.

The setting will turn on/off each time you press the [SPEED] button.

- * Whenever the unit has remained inactive for a predetermined amount of time, it will go back to displaying the Source (Sound Source) screen.



2 Use the [+] [-] buttons to adjust the playback speed.

If you press the [ENTER] button, the value will return to "100."



- * If you change the speed setting during playback, the audio will be interrupted momentarily.

Value (units: %)	Explanation
50 (1/2 speed)–100 (factory setting)–200 (2x normal speed)	Decreasing this value will slow down the playback, and increasing it will speed up the playback. A setting of "100" is the original playback speed of the song.

3 Press the [EXIT] button twice.

You're returned to the audio source screen.

Remote operations



- FAST** Makes the playback faster.
- SLOW** Makes the playback slower.
- ON/OFF** Turns the playback speed setting on/off.

When you turn off the power, the Speed setting will return to "Off."

Important

Slowing down the playback speed to an extreme extent may change the tonal character or cause the audio to not play back smoothly.

Enjoying Simple Karaoke (Center Cancel)

This function cancels the portion of the sound that is heard in the center of its stereo image, such as the main vocal or lead guitar, making it less audible. This lets you use a commercially available CD as a simple karaoke source, giving you an easy way to enjoy karaoke or to practice singing or playing an instrument.

- 1 Press the [CENTER CANCEL] button to access the “Center Cancel” screen.**
The setting will turn on/off each time you press the [CENTER CANCEL] button.

* Whenever the unit has remained inactive for a predetermined amount of time, it will go back to displaying the Source (Sound Source) screen.



- ① Press the [CENTER CANCEL] button to access the menu screen.**

- 2 Use the [+] [-] buttons to change the CENTER CANCEL setting.**



Value	Explanation
On1 (factory setting)	The “On 1” through “On 3” settings produce different center cancellation effects. Try each setting, and use the one that is best for your situation.
On2	
On3	
Focus1	Boosts the sound that is heard from the center when the song is played back. “Focus 1” and “Focus 2” provide different types of boost. Try each setting, and use the one that is best for your situation.
Focus2	

- 3 Press the [EXIT] button.**

You’re returned to the audio source screen.

When you turn off the power, the Center Cancel setting will return to the “Off” state.

Important

You may fail to obtain the desired effect if the song has deep reverb, or if the sounds you want to eliminate are not positioned in the center.

Remote operations



 Turns Center Cancel on/off.

Repeatedly Playing Tracks (1 Track/All Repeat)

You can have a favorite track (or all tracks) play back repeatedly.

- 1 Press the [MENU] button to access the menu screen, and choose "Repeat."



- 1 Press the [MENU] button to access the menu screen.
- 2 Use the [<] [>] buttons to choose "Repeat."
- 3 Press the [ENTER] button to confirm your choice.

- 2 Use the [+] [-] buttons to change the Repeat Playback setting.



Value	Explanation
Off (factory setting)	Repeat Playback will be off.
1 Track	One-track repeat. The currently playing track, or any track you play subsequently, will play back repeatedly.
All Tracks	All repeat. All tracks will play repeatedly. If you select this during playback, all tracks will play repeatedly, starting with the currently playing track.

- 3 Press the [EXIT] button twice.

You're returned to the audio source screen.

The Repeat icons

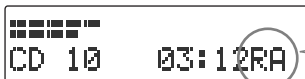

The following icon is displayed if you've specified Repeat Playback.

R1 (1 track repeat) RA (All repeat)

The "R1" or "RA" symbol will disappear if you set the "Repeat" to "Off" in Step 2.

Important

The Repeat Playback setting will be turned "Off" if you operate the [REPEAT] button.

Repeatedly playing a portion of the song (A/B Repeat)

You can have a specified section play back repeatedly.

Repeatedly listening to a section of a song is convenient when you're practicing your instrument along with the song, or learning the song by ear.

- 1 During playback, press the [REPEAT] button at the point where you want Repeat Play to start.**

The starting point (A) of A-B Repeat playback is registered, and the Point A icon blinks.

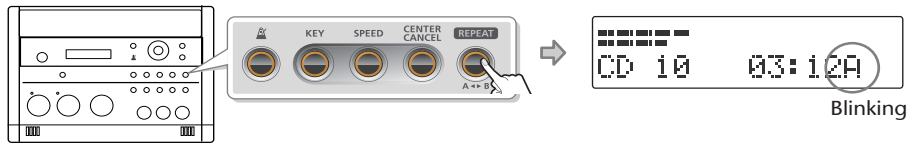

- 2 Press the [REPEAT] button once again at the point where you want A-B Repeat to end.**

The end point (B) of A-B Repeat playback is registered, and the A-B region will play back repeatedly.

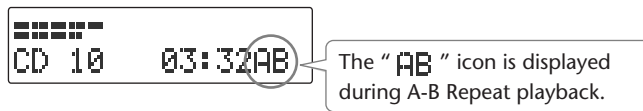

- 3 To defeat A-B Repeat, press the [REPEAT] button while A-B Repeat playback is occurring.**

If you press the [■] (Stop) button to stop playback, A-B Repeat playback will also be cancelled.

Remote operations



Register the start/end points for A-B Repeat.

Sounding the Metronome

The CD-2u/SD-2u has built-in metronome—a convenient feature for practicing an instrument.

1 Press the [] (Metronome) button to turn the metronome on.

The setting will turn on/off each time you press the [] (Metronome) button.

- * Whenever the unit has remained inactive for a predetermined amount of time, it will go back to displaying the Source (Sound Source) screen.

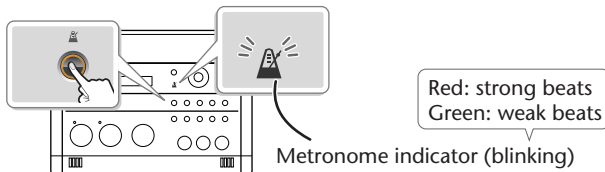



If the metronome is on, the [] (Metronome) button will light. At the same time, the metronome's indicator will start blinking on the beat.

When you press the [] (Metronome) button once again, the metronome will turn off (unlit).

2 Setting the sound.



Sound : Bell

- 1 Press the [] (Metronome) button to access the menu screen.
- 2 Use the [] buttons to choose "Sound."
- 3 Use the [+] [-] buttons to select the desired metronome sound.

Value	Explanation
Silent	There will be no sound; the metronome indicator will blink to mark the beats.
Bell (factory setting)	A bell will mark the beats.
Click	An electronic sound will mark the beats.
Voice	A human voice (English) will count the beats

3 Setting the tempo.

Tempo : 120

- 1 Use the [] [] buttons to choose "Tempo."
- 2 Specify the tempo of the metronome.
 - Use the [+] [-] buttons to change the tempo value.
 - Specify the desired tempo by tapping it out using the [ENTER] button.

Value	Explanation
♩ = 20–120 (factory setting)–250	Specifies the number of quarter-notes in one minute. Decreasing this value will make the tempo slower. Increasing this value will make the tempo faster.

4 Specifying which beats are emphasized.



- ① Use the [<] [>] buttons to choose “Beat.”
- ② Use the [+] [-] buttons to specify the timing at which the metronome will mark the strong beats.

Value	Explanation
0	No beats are emphasized.
1	Every beat is emphasized.
2	Every second beat is emphasized.
3	Every third beat is emphasized.
4 (factory setting)	Every fourth beat is emphasized.
5	Every fifth beat is emphasized.
6	Every sixth beat is emphasized.
7	Every seventh beat is emphasized.
	Each beat is divided into a triplet, and an emphasized beat will sound at the beginning of each triplet.
	Each beat is divided into sixteenth notes, and an emphasized beat will sound on the sixteenth note at the beginning of each beat.

- * (a quarter-note) will be counted as one beat.
- * If you’ve selected “Voice” as the “Sound” setting, there will be no accent on the strong beats.

5 Adjust the volume.



- ① Use the [<] [>] buttons to choose “Level.”
- ② Use the [+] [-] buttons to adjust the metronome volume as desired.

6 Adjust the output destination.

- ① Use the [<] [>] buttons to choose “Monitor.”
- ② Use the [+] [-] buttons to specify the output destination.

Value	Explanation
All	Output to speakers, headphones, and all outputs.
Phones	Output only to headphones.

7 Press the [EXIT] button.

You’re returned to the audio source screen.

Important

- The metronome sound will not be audible during recording standby or while recording. If you want to hear the metronome, you’ll need to use headphones.
- The metronome cannot be used while overdubbing a performance with a music CD (Page 54).

Remote operations



- Specify the metronome tempo.
- Make the tempo faster.
- Make the tempo slower.
- Turn the metronome on/off.

Tuning Your Instrument (Tuner Function)

You can tune your instrument using the chromatic tuner function, which detects the name of the note in semitone steps.

1 Select the internal mics.

- ① Press the [MENU] button to access the menu screen.
- ② Use the [<] [>] buttons to choose "MIC Select."



```
AUDIO          <>
MIC Select
```

- ③ Press the [ENTER] button to confirm your choice.
- ④ Use the [+] [-] buttons to change the value to select "Internal."



```
MIC Select
: Internal
```

2 Press the [EXIT] button twice.

You're returned to the audio source screen.

3 Press the [MENU] button to access the menu screen, and choose "Tuner/Tone?"



```
TUNER          <>
Tuner/Tone?
```

- ① Press the [MENU] button to access the menu screen.
- ② Use the [<] [>] buttons to choose "Tuner/Tone?"
- ③ Press the [ENTER] button to confirm your choice.

4 Watch the tuner screen, and play a note on the instrument you want to tune.



```
TUNER Pitch:440
.....+.....
```



```
TUNER Pitch:440
▶...0+..... C#4
```

Note Name

The name of the note closest to the pitch you played will appear in the tuner screen. Tune your instrument so that the desired note name appears.

If the tuner does not respond, make sure that the [MIC] knob's level is raised.

Important

SD-2u only

You can press the [TUNER] button to access the screen of step 4.

5 Tune the instrument so that the left and right tuning guides are both displayed.

When your instrument is within ± 50 cents of the correct pitch, a tuning guide will appear in the screen. This indicates the distance between the displayed note name and the pitch your instrument is actually producing.

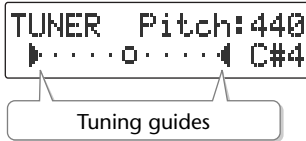

Tune your instrument so that the left and right guides are visible.

When only the right guide is displayed:



The pitch is above the displayed note name (i.e., sharp).

When only the left guide is displayed:



The pitch is below the displayed note name (i.e., flat).

6 When you're finished using the tuner, press the [EXIT] button twice.

You're returned to the audio source screen.

Important

- The tuner can also use the external mics. When you want to use the external mics, choose MIC SELECT from the menu, then set it to "External."
 - ☞ "Select the External mics." (Page 46)
- You can't play back or record while using the tuner.
- If you don't want to hear sound while you're tuning, you can turn down the [VOLUME] knob or turn the speakers off so that the sound is muted.

Changing the Tuner's Reference Pitch

You can calibrate the CD-2u/SD-2u's Tuner to another instrument or tuning standard by adjusting its "reference pitch."

The reference pitch is the frequency of the A4 note. This is the pitch of the middle A note on a piano.

1 Press the [MENU] button to access the menu screen, and choose "Tuner/Tone?"



- ① Press the [MENU] button to access the menu screen.
- ② Use the [<] [>] buttons to choose "Tuner/Tone?"
- ③ Press the [ENTER] button to confirm your choice.

2 Use the [+] [-] buttons to adjust the reference pitch as desired.



Value (units: Hz)	Explanation
435–440 (factory setting)–445	Decreasing this value will lower the pitch. Increasing this value will raise the pitch.

3 Press the [EXIT] button twice.

You're returned to the audio source screen.

Listening to a Guide Tone While Tuning

As a tuning aid, you can have the CD-2u/SD-2u sound a guide tone from the internal speakers.

1 Press the [MENU] button to access the menu screen, and choose "Tuner/Tone?"



- ① Press the [MENU] button to access the menu screen.
- ② Use the [<] [>] buttons to choose "Tuner/Tone?"
- ③ Press the [ENTER] button to confirm your choice.

2 While the tuner screen is displayed, press the [ENTER] button.

(The tuner screen and the guide tone screen will alternate each time you press the [ENTER] button.)

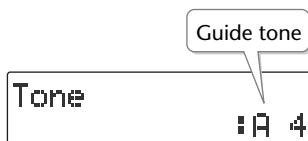

You'll hear the guide tone shown in the screen.

3 Use the [+] [-] buttons to select the name of the note you want to use as the guide tone.

Value	Explanation
A3–A4 (factory setting)–A5	You can choose one of 25 chromatic notes in the range A3–A5.

4 Tune your instrument to the guide tone.

5 To stop the guide tone, press the [EXIT] button twice.

You're returned to the audio source screen.

Important

SD-2u only

You can press the [GUIDE TONE] button to access the screen of step 2.

Deleting Songs from an SD Memory Card

Deleting Songs Individually

Here's how to delete a single, selected song.

When you delete a song, subsequent songs will be moved forward, incrementing their song numbers.

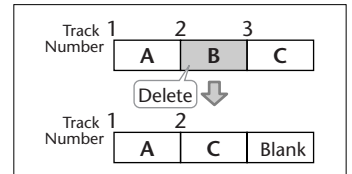

- 1** Insert the SD memory card that you want to edit, and press the [SD CARD] button **CD-2u only**.

SD becomes the audio source.

- 2** Use the [◀◀] or [▶▶] button to select the track you want to erase.

- 3** Press the [MENU] button to access the menu screen, and choose "Erase One?"

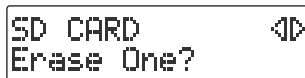

- ① Press the [MENU] button to access the menu screen.
- ② Use the [◀] [▶] buttons to choose "Erase One?"
- ③ Press the [ENTER] button to confirm your choice.

- 4** If you're sure you want to proceed, press the [ENTER] button.

(Note that the process cannot be interrupted once you've started it. If you decide that you don't want to begin the process, press the [EXIT] button.)

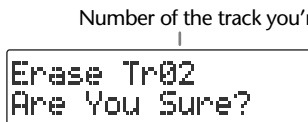

The display will show "Processing..," and the song will be deleted. When the deletion is completed, you're returned to the audio source screen.

Note

Once you delete a song, you cannot recover the recorded content. Use this operation with care.

Important

- If you select the song you want to delete in Step 2 and then press the [-] button, the message screen of Step 4 will appear immediately. This lets you skip the step of selecting the menu item.
- Deletion is not possible if the SD memory card's write protect switch (Page 26) is in the "LOCK" position.



Erasing All Tracks

Here's how to delete all songs from the SD memory card.

- 1 Insert the SD memory card that you want to edit.
- 2 Press the [MENU] button to access the menu screen, and choose "SD Erase All?"



SD CARD
SD Erase All? ◀▶

- ① Press the [MENU] button to access the menu screen.
- ② Use the [◀][▶] buttons to choose "SD Erase All?"
- ③ Press the [ENTER] button to confirm your choice.

- 3 If you're sure you want to proceed, press the [ENTER] button.



SD Erase All
Are You Sure?

- 4 If you're still sure you want to proceed, press the [ENTER] button.

(Note that the process cannot be interrupted once you've started it. If you decide that you don't want to begin the process, press the [EXIT] button.)



SD Erase All
Really Sure?

The display will show "Processing..," and all songs will be deleted. When the deletion is completed, you're returned to the audio source screen.

Note

Once you delete a song, you cannot recover the recorded content. Use this operation with care.

Important

Deletion is not possible if the SD memory card's write protect switch (Page 26) is in the "LOCK" position.

Deleting an Unwanted Region at the Beginning of the Song (Trim In)

If you start recording slightly ahead of the beginning of the performance so as to avoid missing anything, there will be some unwanted silence at the beginning of the song. You can delete this unwanted silence so that you will hear sound as soon as the song starts playing.

- 1 Insert the SD memory card that you want to edit, and press the [SD CARD] button **CD-2u_{only}**.
SD becomes the audio source.

- 2 Use the [◀◀] or [▶▶] button to select the track you want to edit.

- 3 Press the [MENU] button to access the menu screen, and choose “Trim In?”

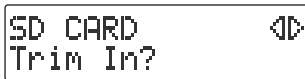

- ① Press the [MENU] button to access the menu screen.
- ② Use the [◀][▶] buttons to choose “Trim In?”
- ③ Press the [ENTER] button to confirm your choice.

- 4 Press the [▶/||] (Play) button to play back the selected song.



Number of the track you're editing

- 5 When you come to the point that you want to be the beginning of the song (the Start Point), press the [●] (Record) button.

Four seconds of sound preceding the Start Point will play repeatedly.

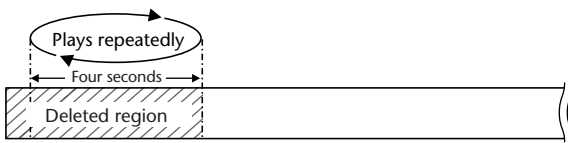

Start Point—this will be the beginning of the song after editing.

- 6 Use the [+] or [-] button to precisely adjust the Start Point.

Adjust the Start Point so that you no longer hear the beginning of the song.

Button	Explanation
[+] button	Moves the Start Point forward.
[-] button	Moves the Start Point backward.

7 Press the [ENTER] button.

8 If you're sure you want to proceed, press the [ENTER] button.

(Note that the process cannot be interrupted once you've started it. If you decide that you don't want to begin the process, press the [EXIT] button.)

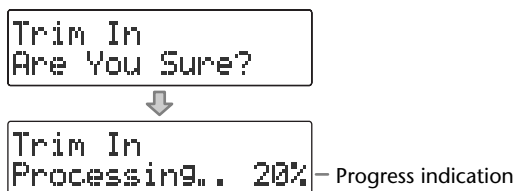

The display will show "Processing..," and the unwanted beginning of the song will be deleted. When the deletion is completed, you're returned to the audio source screen.

Note

The deleted region cannot be recovered. Use this operation with caution.

Important

- You can't specify Start Point locations that would cause the edited song to be less than four seconds long.
- The Trim In editing process will take a certain amount of time. In general, the time will be approximately half the playback time of the song. For example, in order to edit a four-minute song, it will take approximately two minutes for the editing process to be completed.
- The Trim In editing operation requires free space equal to the size of the song you're editing. For example, if you're editing a five-minute song, you won't be able to execute this operation unless you have at least five minutes of recording time remaining.
- This operation cannot be performed if the SD memory card's write protect switch (Page 26) is in the "LOCK" position.

Deleting an Unwanted Region at the End of the Song (Trim Out)

If you stop recording slightly after the end of the performance so as to avoid missing anything, there will be some unwanted silence at the end of the song. You can delete this unwanted silence so that the song contains only the performance itself.

- 1** Insert the SD memory card that you want to edit, and press the [SD CARD] button **CD-2u** only. SD becomes the audio source.

- 2** Use the [◀◀] or [▶▶] button to select the track you want to edit.

- 3** Press the [MENU] button to access the menu screen, and choose “Trim Out?”

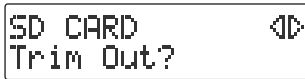

- ① Press the [MENU] button to access the menu screen.
- ② Use the [◀][▶] buttons to choose “Trim Out?”
- ③ Press the [ENTER] button to confirm your choice.

- 4** Press the [▶/||] (Play) button to play back the selected song.

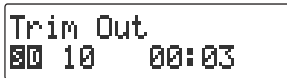

Number of the track you're editing

- 5** When you come to the point that you want to be the end of the song (the End Point), press the [●] (Record) button.

(If the song is long, you can fast-forward until you're near the desired End Point.)
Four seconds of sound following the End Point will play repeatedly.

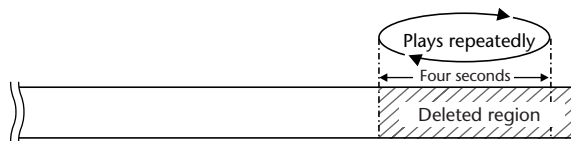

End Point—this will be the end of the song after editing.

- 6** Use the [+] or [-] button to precisely adjust the End Point. Adjust the End Point so that you no longer hear the end of the song.

Button	Explanation
[+] button	Moves the End Point forward.
[-] button	Moves the End Point backward.

7 Press the [ENTER] button.

8 If you're sure you want to proceed, press the [ENTER] button.

(Note that the process cannot be interrupted once you've started it. If you decide that you don't want to begin the process, press the [EXIT] button.)

```
Trim Out
Are You Sure?
```



```
Trim Out
Processing.. 20%
```

— Progress indication

The display will show “Processing..” and the unwanted end of the song will be deleted. When the deletion is completed, you're returned to the audio source screen.

Note

The deleted region cannot be recovered. Use this operation with caution.

Important

- You can't specify End Point locations that would cause the edited song to be less than four seconds long.
- The Trim Out editing process will take a certain amount of time. In general, the time will be approximately half the playback time of the song. For example, in order to edit a four-minute song, it will take approximately two minutes for the editing process to be completed.
- The Trim Out editing operation requires free space equal to the size of the song you're editing. For example, if you're editing a five-minute song, you won't be able to execute this operation unless you have at least five minutes of recording time remaining.
- This operation cannot be performed if the SD memory card's write protect switch (Page 26) is in the “LOCK” position.

Deleting One Song at a Time (Only the Last Song)

Here's how to erase the last track recorded on a CD-RW disc.

* In order to perform this operation, you'll need the included, dedicated AC adaptor.

- 1 Insert the CD-RW disc that you want to edit.
- 2 Press the [MENU] button to access the menu screen, and choose "Erase Last?"



CD-R/RW
Erase Last? →

- ① Press the [MENU] button to access the menu screen.
- ② Use the [<] [>] buttons to choose "Erase Last?"
- ③ Press the [ENTER] button to confirm your choice.

- 3 If you're sure you want to proceed, press the [ENTER] button.
(Note that the process cannot be interrupted once you've started it. If you decide that you don't want to begin the process, press the [EXIT] button.)



Erase Last
Are You Sure?



Erase Last
Processing.. 1:12 — Count-down (min:sec)

The display will show "Processing..," and the last song will be deleted. During this process, a timer is displayed, counting down the time until the operation is completed. When the deletion is completed, you're returned to the audio source screen.

Note

Once you delete a song, you cannot recover the recorded content. Use this operation with care.

Important

- You can't erase tracks from a CD-R disc.
- If you want to erase a track from a CD-RW disc that's been finalized (Page 99), you'll need to first remove finalization. ☞ "Removing Finalization" (Page 94)
- If you press the [-] button after Step 1, the message screen of Step 3 will appear immediately. This lets you skip having to choose a menu item.

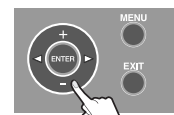

Erasing All Tracks

Here's how to erase all tracks from the CD-RW disc.

* In order to perform this operation, you'll need the included, dedicated AC adaptor.

- 1 Insert the CD-RW disc that you want to edit.
- 2 Press the [MENU] button to access the menu screen, and choose "CD Erase All?"



CD-R/RW
CD Erase All?

- ① Press the [MENU] button to access the menu screen.
- ② Use the [<] [>] buttons to choose "CD Erase All?"
- ③ Press the [ENTER] button to confirm your choice.

- 3 If you're sure you want to proceed, press the [ENTER] button.

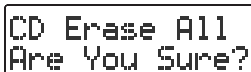

CD Erase All
Are You Sure?

- 4 If you're still sure you want to proceed, press the [ENTER] button.

(Note that the process cannot be interrupted once you've started it. If you decide that you don't want to begin the process, press the [EXIT] button.)

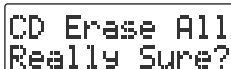

CD Erase All
Really Sure?



CD Erase All
Processing.. 6:58

Count-down (min:sec)

The display will show "Processing..," and all songs will be deleted. During this process, a timer is displayed, counting down the time until the operation is completed.

When the deletion is completed, you're returned to the audio source screen.

Note

Once you delete a song, you cannot recover the recorded content. Use this operation with care.

Important

- You can't erase tracks from a CD-R disc.
- If the CD-R/RW disc has been finalized (Page 99), finalization will automatically be removed when you erase all tracks.

Removing Finalization

You can remove finalization from a CD-RW disc (Page 99) so that the disc can once again be used for recording. Removing finalization will not erase the recorded tracks.

* In order to perform this operation, you'll need the included, dedicated AC adaptor.

1 Insert the CD-RW disc that you want to edit, and press the [CD] button. CD becomes the audio source.

2 Press the [MENU] button to access the menu screen, and choose "Unfinalize?"



```
CD-R/RW  <>
Unfinalize?
```

① Press the [MENU] button to access the menu screen.

② Use the [<] [>] buttons to choose "Unfinalize?"

③ Press the [ENTER] button to confirm your choice.

3 If you're sure you want to proceed, press the [ENTER] button.

(Note that the process cannot be interrupted once you've started it. If you decide that you don't want to begin the process, press the [EXIT] button.)

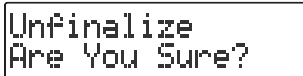

```
Unfinalize
Are You Sure?
```



```
Unfinalize
Processing.. 1:12
```

Count-down (min:sec)

The display will show "Processing..," and finalization will be removed from the disc.

During this process, a timer is displayed, counting down the time until the operation is completed.

When finalization has been removed, you're returned to the audio source screen.

Important

You can't remove finalization from a CD-R disc.

Selecting Songs from an SD Memory Card to Create a CD

CD-2u only

Here's how selected songs from an SD memory card can be written to a CD-R/RW disc to create a music CD.

* In order to perform this operation, you'll need the included, dedicated AC adaptor.

- 1 Insert the SD memory card that contains the songs you want to turn into a music CD.
- 2 Press the [MENU] button to access the menu screen, and choose "Write (SD→CD)?"



CD-R/RW
Write(SD→CD)?

- ① Press the [MENU] button to access the menu screen.
- ② Use the [<] [>] buttons to choose "Write (SD→CD)?"
- ③ Press the [ENTER] button to confirm your choice.

- 3 When you see this screen, insert a blank or un-finalized CD-R/RW disc.

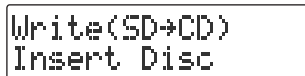

Write(SD→CD)
Insert Disc

* If a CD-R/RW is already inserted, the CD tray will open. Verify that this is a disk to which you don't mind writing new data, and then reinsert the CD-R/RW disc.

- 4 The CD-2u/SD-2u asks whether you want to write all of the songs.

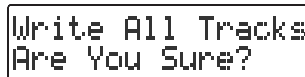

Write All Tracks
Are You Sure?

* This message won't appear if it's not possible for all of the songs on the SD memory card to be written to the CD-R/RW disc. (Proceed to Step 5.)

If you want to write all songs

- ① Press the [ENTER] button.
Proceed to **Step 7**.

If you want to write selected songs

- ① Press the [EXIT] button.
Proceed to **Step 5**.

- 5 Select the song that you want to write to the CD-R/RW disc.

SD memory card track number



SD01 → CD01

CD track number

- ① Using the [<<<] [>>>] or [+] [-] buttons to select the desired song.

If you want to audition the selected song, press the [▶/||] (Play) button. To stop playback, press the [■] (Stop) button.

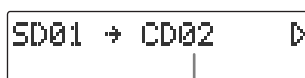

SD01 → CD02

CD track number increases

- ② Press the [ENTER] button to confirm the song to be written.

* To select additional tracks, repeat Step 5.

- 6 When you've selected all of the tracks that you want to write to the CD-R/RW disc, press the [>] button.

7 If you're sure you want to proceed, press the [ENTER] button.

(Note that the process cannot be interrupted once you've started it. If you decide that you don't want to begin the process, press the [EXIT] button.)

```
Write(SD→CD)
Are You Sure?
```

8 Use the [+] [-] buttons to specify the Finalize setting.

* For details on "Finalize," refer to the text box "What's finalization?" on Page 99.

```
Finalize
: No
```

Value	Explanation
Yes	When writing is finished, the disc will be finalized to complete the music CD. No further data can be written to a CD-R/RW disc that has been finalized, even if space remains on the disc. However, if you're using a CD-RW disc, you can remove the finalization and add additional material. "Removing Finalization" (Page 94)
No	The disc will not be finalized when writing is finished. After the tracks have been written, you will still be able to add more tracks if space remains on the disc. If you don't finalize at this point, you can still finalize later to complete your music CD. "Making a CD-R/RW Disc for Playback on Another CD Player (Finalize)" (Page 99)

9 Write to the CD-R/RW disc.

If you selected Finalize "Yes"

- 1 Press the [ENTER] button.
(If you decide to cancel writing, press the [EXIT] button.)
- 2 If you're sure you want to proceed, press the [ENTER] button.
(If you want to return to Step 8, press the [EXIT] button.)

```
Finalize
Are You Sure?
```



Indicates the progress relative to the total number of songs

```
Write(SD→CD) 1/1
Processing.. 12%
```

Indicates the progress for each song

The display will show "Processing..," and writing to the CD-R/RW disc will begin. When writing is completed, the display will show "Finalize...," and the finalization process will begin. Please wait.

When all processing has been completed, the CD-R/RW will be ejected. **Your music CD is now ready.**

If you selected Finalize "No"

- 1 Press the [ENTER] button.
(If you decide to cancel writing, press the [EXIT] button.)

Indicates the progress relative to the total number of songs

```
Write(SD→CD) 1/1
Processing.. 12%
```

Indicates the progress for each song

The display will show "Processing..," and writing to the CD-R/RW disc will begin. Please wait.

When all processing has been completed, the CD-R/RW will be ejected.

10 The CD-2u/SD-2u asks whether you want to create another identical CD.

Write Completed
Another Disc?

If you want to create another identical CD

- ① Press the [ENTER] button.
- ② When you see this screen, insert a blank or un-finalized CD-R/RW disc.

Write(SD→CD)
Insert Disc

Return to **Step 7** and continue the procedure.

If you are finished writing

- ① Press the [EXIT] button to end the procedure.
You're returned to the audio source screen.

Important

- We cannot guarantee that a music CD created on the CD-2u/SD-2u will play on all CD players. Depending on your CD player's support for CD-R/RW discs, music CDs you create may not play correctly.
- Two seconds of silence are automatically inserted between tracks on the CD-R/RW disc when you create a music CD.
- The time required for writing will be approximately half the total playback time of the songs being written. For example, if you're writing songs that total twenty minutes of playback time, the process will require approximately ten minutes.

If you want to create a music CD containing songs from more than one SD memory card

If the CD-R/RW disc has not been finalized, you can add tracks from another SD memory card. If you want to create a music CD using tracks from more than one SD memory card, simply keep adding tracks to a CD-R/RW disc and finalize (Page 99) the disc when you're finished.

* You must turn off the power before exchanging SD memory cards (Page 28).

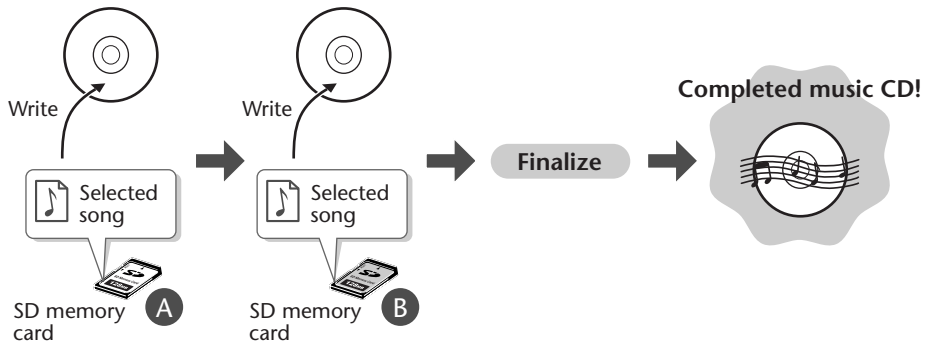

Making a music CD from a song recorded on a device such as the Roland R-05/R-09 series

“WAV 16-bit” and “44.1 kHz” is supported

If you want to create a music CD using songs that were recorded on an R-09, you must set the R-09’s recording mode to “WAV 16-bit” and sampling frequency to “44.1 kHz” before you record.

Requirements for songs (files) that can be recognized

CD-2u/SD-2u recognizes song files that were recorded with a recording mode of “WAV 16bit” and a sample rate of “44.1kHz,” and that meet all of the following conditions.

- Track length must be longer than four seconds.
 - Track title must not contain double-byte characters (e.g., Japanese).
 - Track (file) must be located in the root directory of the SD memory card.
- * The CD-2u/SD-2u is able to display and play back a maximum of 99 tracks.
- * The CD-2u/SD-2u will not recognize the file if even one of the above conditions is not met.

File name display

If the song was recorded on the Roland R-09 series, the song name (file name) will be displayed in Step 5 of Page 95.

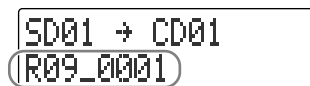

Creating a music CD of a song that won’t fit on a single CD-R/RW disc

Even if a song recorded on a device such as the Roland R-09 series is too large to fit on a single CD-R/RW disc, it can automatically be divided across multiple CD-R/RW discs.

If you want to automatically divide a large song and write it across multiple discs, make the following setting in Step 5 on Page 95.

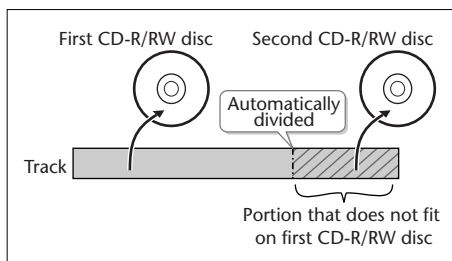

① In Step 5 (Page 95), specify the large song as the “first” of the songs you want to write.

The song will be divided automatically only if the song you specify as the first song is larger than a single CD-R/RW disc. In this case, you won’t be able to specify additional songs to be added. After the first CD-R/RW disc has been ejected, the message “Insert Disc” will appear. Insert another CD-R/RW disc. When the disc is detected, writing will begin automatically. Continue inserting additional CD-R/RW discs as directed by the messages that appear. When all the data has been written, the message “Write Completed. Another Disc?” will appear. Continue with the procedure from Step 10 of Page 97.

- * CD-R/RW discs that have no more space on them after the track has been written will be finalized automatically. For example, if a track is divided across two discs, as in the example shown in the illustration at the upper right, the first CD-R/RW disc will be finalized automatically.

What's finalization?

Finalization is the process of writing final information (the number of songs, the song numbers, the playback times, etc.) to a CD-R/RW disc. When you "finalize" a CD-R/RW disc that was recorded or written by the CD-2u/SD-2u, that disc will be playable as a music CD in another CD player.

After finalization, it will no longer be possible to record or write additional material to that disc. You should finalize the disc when you have completed your music CD and don't need to write or record any more data.

* In order to perform this operation, you'll need the included, dedicated AC adaptor.

1 Insert the CD-R/RW disc that you want to finalize.

2 Press the [EJECT (▲)] button.

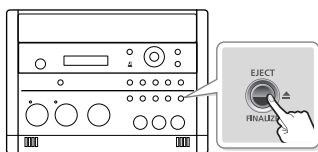

* If the CD-R/RW disc has already been finalized, the disc will be ejected when you press the [EJECT (▲)] button.

3 If you're sure you want to proceed, press the [ENTER] button.

(If you decide not to finalize the disc, press the [EXIT] button.)

```
Finalize  
Are You Sure?
```



```
Finalize  
Processing. . 1:12
```

— Count-down (min:sec)

The disc is finalized. During this process, a timer is displayed, counting down the time until finalization is completed.

When finalization is completed, the CD-R/RW disc is ejected. Your music CD is now ready.

Important

- We cannot guarantee that a music CD created on the CD-2u/SD-2u will play on all CD players. Depending on your CD player's support for CD-R/RW discs, music CDs you create may not play correctly.
- With a CD-RW disc, you can remove the finalization so that you'll again be able to record or write to that disc.  "Removing Finalization" (Page 94)

Here's how to back up an original music CD you created, making an identical copy of your original music CD.

* In order to perform this operation, you'll need the included, dedicated AC adaptor.

Workflow to Back up CDs

- ① When copying a music CD, the CD tracks are stored temporarily on an SD memory card.
- ② The temporary tracks on the SD memory card are written to a blank CD-R/RW disc. (The CD-R/RW disc will be finalized automatically.)

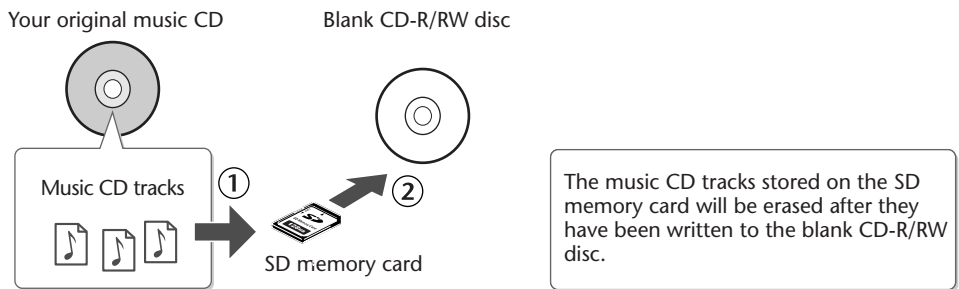

1 Insert an SD memory card to hold the music CD tracks.

The music CD's tracks will be stored up to the amount of free space available on the SD memory card. You may not be able to copy an entire CD if there's not enough free space remaining. If you use an SD memory card with 700 MB or more of free space, you will be able to copy an entire music CD.

2 Press the [MENU] button to access the menu screen, and choose "Make Backup?"



- ① Press the [MENU] button to access the menu screen.
- ② Use the [<] [>] buttons to choose "Make Backup?"
- ③ Press the [ENTER] button to confirm your choice.

3 When you see this screen, insert the music CD that you want to back up.



— Indicates the progress relative to the total number of songs
 — Indicates the progress for each song

When the music CD has been detected, the display will show "Reading CD" and the song data from the music CD will be written to the SD memory card.

When the song data has been written, the music CD will be ejected. Remove the CD.

4 When you see this screen, insert a blank CD-R/RW disc.

```
Make Backup
Insert Blank CD
```

5 If you're sure you want to proceed, press the [ENTER] button.

(Note that the process cannot be interrupted once you've started it. If you decide that you don't want to begin the process, press the [EXIT] button.)

```
Make Backup
Are You Sure?
```



```
Make Backup 10/13
Processing.. 20%
```

— Indicates the progress relative to the total number of songs
— Indicates the progress for each song

The display will show "Processing..," and the backup will begin. When the backup is finished, the CD-R/RW disc will be ejected.

6 The CD-2u/SD-2u asks whether you want to create another identical CD.

```
Make Backup
Another Disc?
```

If you want to create another identical CD

- ① Press the [ENTER] button.
- ② When you see this screen, insert a blank or appendable CD-R/RW disc.

```
Make Backup
Insert Blank CD
```

Return to **Step 5** and continue the procedure.

If you are finished backing up

- ① Press the [EXIT] button to end the procedure.
You're returned to the audio source screen.
Play back the newly written CD-R/RW disc (Page 70) to verify that it was written correctly.

* All song data that was stored on the SD memory card will be erased. It may take a considerable amount of time to complete the erasure.

Important

- You can't back up a CD-R/RW disc that has not been finalized (Page 99).
- Backing up a music CD will require some time for processing to be completed. The time required for backup will be approximately equal to the total playback time of the CD. For example, it will take approximately twenty minutes to back up a twenty-minute CD.

If the screen shows "Tr ##/xx Tr. Are You Sure?" (Step 3)

The music CD's tracks will be written as far as the free space on the SD memory card allows. This means that if the SD memory card contains less free space than the amount of data from the music CD, you won't be able to record all of the tracks.

In this case, the message "Copy ##/xx Tr. Are You Sure?" will appear. This indicates that of the total number of tracks (xx), only Track 1 through Track ## will be copied.

Number of tracks to be copied/total number of tracks on CD

A screenshot of a screen displaying the message "Copy 10/13 Track Are You Sure?" in a monospaced font. A vertical line points from the text "Number of tracks to be copied/total number of tracks on CD" above to the "10/13" part of the message.

Verify the number of tracks for recording, and press the [ENTER] button to continue the procedure. If you decide to cancel, press the [EXIT] button.

If the screen shows "Obey Copyright?" (Step 3)

Carefully read the section "Copyrights / Licenses / Trademarks" (Page 13) of the back cover of the owner's manual, and if you consent to the terms and want to continue the procedure, press the [ENTER] button. If you decide to cancel the procedure, press the [EXIT] button.

If the screen shows "Obey License?" (Step 3)

Carefully read the section "About the Licenses Agreement" (Page 13) of the back cover of the owner's manual, and if you consent to the terms and want to continue the procedure, press the [ENTER] button. If you decide to cancel the procedure, press the [EXIT] button.

If the display shows "SD No Enough Mem" (Step 3)

A backup could not be created due to insufficient free space on the SD memory card. Use an SD memory card that has enough free space.

If the display shows "Short of Capa" (Step 4)

If the capacity of the CD-R/RW disc is less than the amount of data stored on the SD memory card, the message "Short Of Capa" will appear, and the CD-R/RW disc will be ejected.

Please insert a CD-R/RW disc with more writable space.

Moving a Song

This operation moves a song by changing the order of the songs.

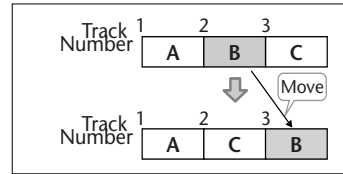

- 1** Insert the SD memory card that you want to edit, and press the [SD CARD] button **CD-2U** only. SD becomes the audio source.
- 2** Use the [◀◀] [▶▶] buttons to select the song that you want to move.
- 3** Press the [MENU] button to access the menu screen, and choose “Move?”



- ① Press the [MENU] button to access the menu screen.
- ② Use the [◀] [▶] buttons to choose “Move?”
- ③ Press the [ENTER] button to confirm your choice.

- 4** Select the move destination.

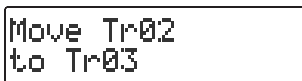

Number of the track
at the move destination

- ① Use the [+] [-] buttons to select the move-destination song number.
- ② Press the [ENTER] button to confirm your choice.

In the example screen shown here, the song will be moved so it becomes the third song.

- 5** If you're sure you want to proceed, press the [ENTER] button.
(Note that the process cannot be interrupted once you've started it. If you decide that you don't want to begin the process, press the [EXIT] button.)

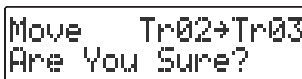

The display will show “Processing..,” and the song will be moved. When the move is completed, you're returned to the audio source screen.

Important

This operation cannot be performed if the SD memory card's write protect switch (Page 26) is in the “LOCK” position.

Dividing a Track

This operation divides a song into two songs.

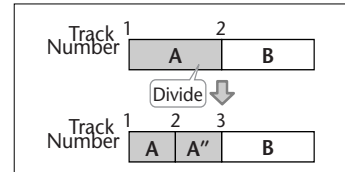

- 1** Insert the SD memory card that you want to edit, and press the [SD CARD] button **CD-2u** only.
SD becomes the audio source.
- 2** Use the [◀◀] or [▶▶] button to select the track you want to edit.
- 3** Press the [MENU] button to access the menu screen, and choose “Divide?”

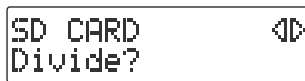

- ① Press the [MENU] button to access the menu screen.
- ② Use the [◀][▶] buttons to choose “Divide?”
- ③ Press the [ENTER] button to confirm your choice.

- 4** Press the [▶/||] (Play) button to play back the selected song.



Number of the track you're editing

- 5** At the approximate location at which you want to divide the song (the dividing point), press the [●] (Record) button.
(If the song is long, you can fast-forward until you're near the desired point.)
The four seconds starting immediately before the dividing point will be played repeatedly.
- 6** Use the [+] [-] buttons to make detailed adjustments to the dividing point.

Button	Explanation
[+] button	Moves the Dividing Point forward.
[-] button	Moves the Dividing Point backward.

- 7** Press the [ENTER] button.

8 If you're sure you want to proceed, press the [ENTER] button.

(Note that the process cannot be interrupted once you've started it. If you decide that you don't want to begin the process, press the [EXIT] button.)

```
Divide
Are You Sure?
```



```
Divide
Processing.. 20%
```

— Progress indication

The display will show "Processing..," and the song will be divided.

When the division is completed, you're returned to the audio source screen.

Important

- This editing process will take a certain amount of time. In general, the time will be approximately half the playback time of the song. For example, in order to edit a four-minute song, it will take approximately two minutes for the editing process to be completed.
- Dividing a song will require free space equal to the size of the song you're editing. For example, if you're editing a five-minute song, you won't be able to execute this operation unless you have at least five minutes of recording time remaining.
- You can't edit a track that is shorter than eight seconds.
- You can't specify Dividing Point locations that would cause the edited song to be less than four seconds long.
- This operation cannot be performed if the SD memory card's write protect switch (Page 26) is in the "LOCK" position.

Joining Songs

This operation join two songs, making them into a single song. The song will be joined with the following song.

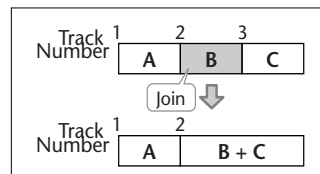

- 1** Insert the SD memory card that you want to edit, and press the [SD CARD] button **CD-2u** only .
SD becomes the audio source.
- 2** Use the [⏮] [⏭] buttons to select the song you want to join.
This song will be joined with the song that follows it.
- 3** Press the [MENU] button to access the menu screen, and choose "Combine?"

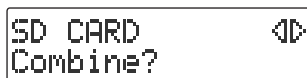

- ① Press the [MENU] button to access the menu screen.
- ② Use the [◀][▶] buttons to choose "Combine?"
- ③ Press the [ENTER] button to confirm your choice.

- 4** If you're sure you want to proceed, press the [ENTER] button.
(Note that the process cannot be interrupted once you've started it. If you decide that you don't want to begin the process, press the [EXIT] button.)

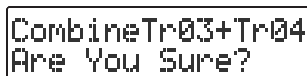

The display will show "Processing..," and the songs will be joined.
When the operation is completed, you're returned to the audio source screen.

Important

- This editing process will take a certain amount of time. The time required for this operation will be approximately half the playback time of two songs you're joining. For example, if you're joining a five-minute song and a three-minute song, processing will take approximately four minutes.
- Joining two songs will require free space equal to the size of the two songs being joined. For example, if you're joining a five-minute song and a three-minute song, you won't be able to execute this operation unless you have at least eight minutes of recording time remaining.
- This operation cannot be performed if the SD memory card's write protect switch (Page 26) is in the "LOCK" position.

Maximizing the Volume of a Song

This operation raises the volume of the entire song as high as possible without causing the sound to distort. If the sound was recorded at too low a level, you can use this to increase the volume.

- 1** Insert the SD memory card that you want to edit, and press the [SD CARD] button **CD-2u** only.
SD becomes the audio source.
- 2** Use the [◀◀] or [▶▶] button to select the track you want to edit.

- 3** Press the [MENU] button to access the menu screen, and choose “Normalize?”

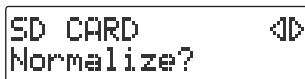

```
SD CARD  ◀▶
Normalize?
```

- ① Press the [MENU] button to access the menu screen.
- ② Use the [◀][▶] buttons to choose “Normalize?”
- ③ Press the [ENTER] button to confirm your choice.

- 4** If you're sure you want to proceed, press the [ENTER] button.
(Note that the process cannot be interrupted once you've started it. If you decide that you don't want to begin the process, press the [EXIT] button.)

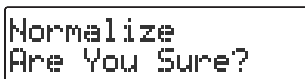

```
Normalize
Are You Sure?  ▶
```



```
Normalize
Checking...  20%
```

— Progress indication

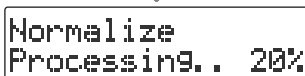

```
Normalize
Processing.. 20%
```

— Progress indication

The display will show “Processing..,” and the volume of the song will be raised. When the operation is completed, you're returned to the audio source screen.

- * If the volume of the song has already been maximized, the display will indicate “Checking...,” and then the editing process will end.

Important

- This editing process will take a certain amount of time. The time required for this operation will be approximately 1.5 times the playback time of the song. For example, if you apply this operation to a four-minute song, processing will take approximately six minutes.
- Maximizing the volume of a song will require free space equal to the size of the song you're editing. For example, if you're editing a five-minute song, you won't be able to execute this operation unless you have at least five minutes of recording time remaining.
- This operation cannot be performed if the SD memory card's write protect switch (Page 26) is in the “LOCK” position.

Creating a Copy of a Song in a New Key

You can change the key of a song on an SD memory card (or CD **CD-2u_{only}**), and save the new version of the song on the SD memory card.

- * In order to edit a song on CD, you'll need to use the dedicated AC adaptor (included) **CD-2u_{only}**.

1 Insert the media that contains the song you want to edit.

- * The copy of the song in the new key will be created on the SD memory card. If you want to edit a song that's on a CD, you'll need to provide both the CD and the SD memory card **CD-2u_{only}**.

2 Select the song whose key you want to change.

3 Press the [MENU] button to access the menu screen, and choose "Change Key?"



- ① Press the [MENU] button to access the menu screen.
- ② Use the [<] [>] buttons to choose "Change Key?"
- ③ Press the [ENTER] button to confirm your choice.

4 Use the [+] [-] buttons to change the key setting, and press the [ENTER] button.

If you've changed the key as described in "Changing the Key of the Playback" (Page 75), that value will be applied.



- * If you want to audition the song, press the [▶/II] (Play) button.

5 If you're sure you want to proceed, press the [ENTER] button.

(Note that the process cannot be interrupted once you've started it. If you decide that you don't want to begin the process, press the [EXIT] button.)



— Media and song number of the song to be edited

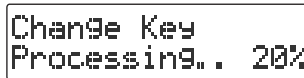

— Progress indication

The display will show "Processing..," and the operation will be performed. When processing has been completed, you're returned to the audio source screen, and the copy of the song in the new key will be added at the end of the SD memory card.

Important

- This editing process will take a certain amount of time. In general, the time will be approximately the playback time of the song.
- The SD memory card must have enough free space to contain the newly created song. For example, if you're editing a five-minute song, you won't be able to execute the operation unless the SD memory card has at least five minutes of recording time remaining.
- Pitch, playback speed, and Center Cancel settings are not reflected in the resulting song copy.
- This operation cannot be performed if the SD memory card's write protect switch (Page 26) is in the "LOCK" position.

Creating a Copy of a Song in a New Pitch

You can change the pitch of a song on an SD memory card (or CD **CD-2u only**), and save the new version of the song on the SD memory card.

* In order to edit a song on CD, you'll need to use the dedicated AC adaptor (included) **CD-2u only**.

1 Insert the media that contains the song you want to edit.

* The copy of the song in the new pitch will be created on the SD memory card. If you want to edit a song that's on a CD, you'll need to provide both the CD and the SD memory card **CD-2u only**.

2 Select the song whose pitch you want to change.

3 Press the [MENU] button to access the menu screen, and choose "Change Pitch?"

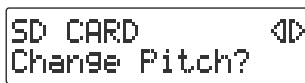

- ① Press the [MENU] button to access the menu screen.
- ② Use the [<] [>] buttons to choose "Change Pitch?"
- ③ Press the [ENTER] button to confirm your choice.

4 Use the [+] [-] buttons to change the pitch setting, and press the [ENTER] button.

If you've changed the pitch as described in "Making Fine Adjustments to the Playback Pitch (Pitch)" (Page 76), that value will be applied.



* If you want to audition the song, press the [▶/II] (Play) button.

5 If you're sure you want to proceed, press the [ENTER] button.

(Note that the process cannot be interrupted once you've started it. If you decide that you don't want to begin the process, press the [EXIT] button.)



— Media and song number of the song to be edited



— Progress indication

The display will show "Processing..," and the operation will be performed. When processing has been completed, you're returned to the audio source screen, and the copy of the song in the new pitch will be added at the end of the SD memory card.

Important

- This editing process will take a certain amount of time. In general, the time will be approximately the playback time of the song.
- The SD memory card must have enough free space to contain the newly created song. For example, if you're editing a five-minute song, you won't be able to execute the operation unless the SD memory card has at least five minutes of recording time remaining.
- Pitch, playback speed, and Center Cancel settings are not reflected in the resulting song copy.
- This operation cannot be performed if the SD memory card's write protect switch (Page 26) is in the "LOCK" position.

Creating a Copy of a Song at a New Playback Speed

You can change the playback speed of a song on an SD memory card (or a CD **CD-2U only**), and save the new version of the song on the SD memory card.

* In order to edit a song on CD, you'll need to use the dedicated AC adaptor (included) **CD-2U only**.

1 Insert the media that contains the song you want to edit.

* The song with the new playback speed will be created on the SD memory card. If you want to edit a song that's on a CD, you'll need to provide both the CD and the SD memory card **CD-2U only**.

2 Select the song whose speed you want to change.

3 Press the [MENU] button to access the menu screen, and choose "Change Speed?"



SD CARD <D>
Change Speed?

① Press the [MENU] button to access the menu screen.

② Use the [<] [>] buttons to choose "Change Speed?"

③ Press the [ENTER] button to confirm your choice.

4 Use the [+] [-] buttons to change the playback speed setting, and press the [ENTER] button.

If you've changed the pitch as described in "Slowing Down or Speeding Up Playback" (Page 77), that value will be applied.



Speed
: 90

* If you want to audition the song, press the [▶/II] (Play) button.

5 If you're sure you want to proceed, press the [ENTER] button.

(Note that the process cannot be interrupted once you've started it. If you decide that you don't want to begin the process, press the [EXIT] button.)



Change Speed CD03
Are You Sure?

— Media and song number of the song to be edited

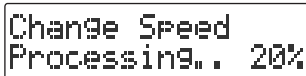

Change Speed
Processing.. 20%

— Progress indication

The display will show "Processing..," and the operation will be performed. When processing has been completed, you're returned to the audio source screen, and the copy of the song at the new playback speed will be added at the end of the SD memory card.

Important

- It will take some time for this operation to take place. The maximum time required for processing will be approximately 1.5 times the playback time of the song. (This will depend on the playback speed setting.) For example, if you're editing a four-minute song at a playback speed of 50 (half speed), processing will take approximately six minutes.
- The SD memory card must have enough free space to contain the newly created song. For example, if you're editing a four-minute song at a playback speed of 50 (half speed), you won't be able to execute the operation unless the SD memory card has at least eight minutes of recording time remaining.
- This operation cannot be executed if the length of the song after editing would be less than four seconds.
- Key, pitch, and Center Cancel settings are not reflected in the resulting song copy.
- This operation cannot be performed if the SD memory card's write protect switch (Page 26) is in the "LOCK" position.

Creating a Copy of a Song with the Center Cancelled

You can make simple karaoke material from a song on an SD memory card (or CD **CD-2u only**) by using the “Enjoying Simple Karaoke (Center Cancel)” (Page 78), then saving the new version of the song on an SD memory card.

* In order to edit a song on CD, you'll need to use the dedicated AC adaptor (included) **CD-2u only**.

1 Insert the media that contains the song you want to edit.

* A copy of the song, to which the center cancel effect has been applied, will be created on the SD memory card. If you want to edit a song that's on a CD, you'll need to provide both the CD and the SD memory card **CD-2u only**.

2 Select the song from which you want to make simple karaoke material.

3 Press the [MENU] button to access the menu screen, and choose “Center Cancel?”



SD CARD
Center Cancel? →

① Press the [MENU] button to access the menu screen.

② Use the [<] [>] buttons to choose “Center Cancel?”

③ Press the [ENTER] button to confirm your choice.

4 Use the [+] [-] buttons to select the type of Center Cancel, and press the [ENTER] button.



Center Cancel
:On2

* If you want to audition the song, press the [▶/II] (Play) button.

5 If you're sure you want to proceed, press the [ENTER] button.

(Note that the process cannot be interrupted once you've started it. If you decide that you don't want to begin the process, press the [EXIT] button.)

—Media and song number of the song to be edited

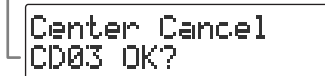

Center Cancel
CD03 OK?



Center Cancel
Processing.. 20%

—Progress indication

The display will show “Processing..,” and the operation will be performed.

When processing has been completed, you're returned to the audio source screen, and the song that's been prepared for use with karaoke will be added at the end of the SD memory card.

Important

- This editing process will take a certain amount of time. In general, the time will be approximately the playback time of the song.
- The SD memory card must have enough free space to contain the newly created song. For example, if you're editing a five-minute song, you won't be able to execute the operation unless the SD memory card has at least five minutes of recording time remaining.
- Key, pitch, and playback speed settings are not reflected in the resulting song copy.
- This operation cannot be performed if the SD memory card's write protect switch (Page 26) is in the “LOCK” position.

Viewing the Remaining Recording/Playback Time

Here's how to switch the time information shown in the screen. You can view the remaining time that can be recorded on an SD memory card (or CD-R/RW disc **CD-2U only**), or the time remaining in a song.

Press the [ENTER] button to switch between the available choices for the time indicator, as follows.

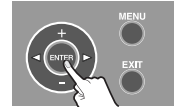

During recording or recording standby

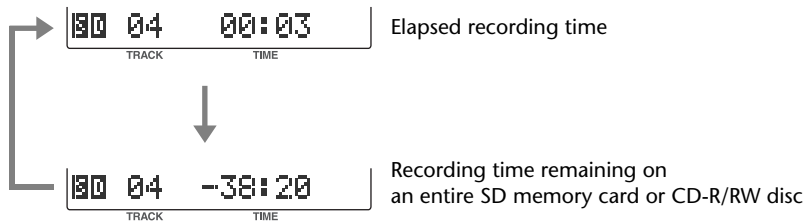

During playback or while stopped

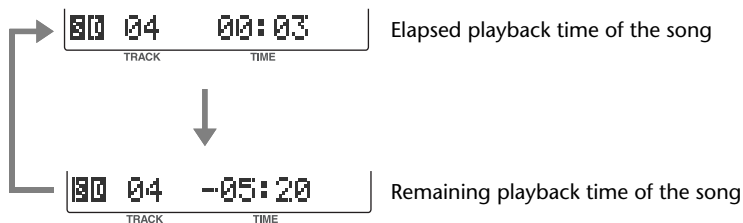

Important

You can also check the remaining recording time by viewing information about the SD memory card or CD-R/RW disc. For details, refer to the following pages.

- ☞ Page 113, "Viewing Information about an SD Memory Card"
- ☞ Page 114, "Viewing Information about a CD-R/RW Disc"

Viewing Information about an SD Memory Card

Here's how to view information such as the capacity of an SD memory card and the remaining time for recording.

- 1 Press the [MENU] button to access the menu screen, and choose "Card Info."**



SD CARD <▶
Card Info

- ① Press the [MENU] button to access the menu screen.
- ② Use the [<] [>] buttons to choose "Card Info."
- ③ Press the [ENTER] button to confirm your choice.

- 2 View the information.**



Card Info 2GB
Remain 150:22

— Total capacity of the SD memory card
— Remaining recording time

- 3 Press the [EXIT] button twice.**
You're returned to the audio source screen.

Here's how to view information such as the capacity of a CD-R/RW disc and the remaining time for recording.

1 Press the [MENU] button to access the menu screen, and choose "Disc Info."



```
CD-R/RW  <|>
Disc Info
```

- ① Press the [MENU] button to access the menu screen.
- ② Use the [<] [>] buttons to choose "Disc Info."
- ③ Press the [ENTER] button to confirm your choice.

2 View the information.



```
Disc Info 700MB
Remain    68:22
```

— Total capacity of the CD-R/RW disc
— Remaining recording time

3 Press the [EXIT] button twice.

You're returned to the audio source screen.

Important

The total capacity and remaining recording time are not shown for a finalized (Page 99) CD-R/RW disc or a music CD.

Adjusting the Readability of the Screen (Contrast)

Depending on the temperature or other conditions, the characters in the screen may become difficult to read. In such cases, you can adjust the contrast for best readability.

- 1 Press the [MENU] button to access the menu screen, and choose "Contrast."



- ① Press the [MENU] button to access the menu screen.
- ② Use the [<] [>] buttons to choose "Contrast."
- ③ Press the [ENTER] button to confirm your choice.

- 2 Use the [+] [-] buttons to adjust the contrast of the screen.

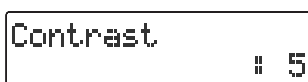

Value	Explanation
1-5 (factory setting)-8	Decreasing the value will lighten the screen. Increasing the value will darken the screen.

- 3 Press the [EXIT] button twice.
You're returned to the audio source screen.

Important

You can also adjust the screen contrast by holding down the [MENU] button and using the [+] [-] buttons.

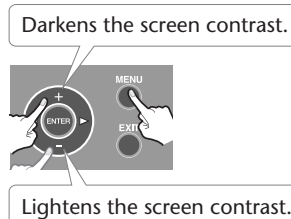

Automatically Dimming the Screen (Backlight Timer)

If you're operating the CD-2u/SD-2u on batteries (Page 24), you can set this function so that the screen will automatically be dimmed to conserve batteries after no operation has been performed for a certain length of time.

* This setting is effective only when the CD-2u/SD-2u is running on batteries. The screen will not dim if you're using the dedicated AC adaptor (Page 22).

1 Press the [MENU] button to access the menu screen, and choose "Backlight Timer."



SYSTEM
Backlight Timer

① Press the [MENU] button to access the menu screen.

② Use the [<] [>] buttons to choose "Backlight Timer."

③ Press the [ENTER] button to confirm your choice.

2 Use the [+] [-] buttons to specify the time after which the backlight will automatically be dimmed.



Backlight Timer
5 sec

Value	Explanation
Off	The backlight will always remain lit.
2 sec	
5 sec	The backlight will automatically go dark when the specified time has elapsed following an operation.
10 sec	
20 sec (factory setting)	

3 Press the [EXIT] button twice.

You're returned to the audio source screen.

Changing the Screen Display Language

You can switch the screen display between various languages. You can choose from English, Japanese, Spanish, German, French, and Italian.

- 1 Turn off the power.**
- 2 Refer to the table below, and while holding down the button that corresponds to the desired screen display language, turn on the power.** For example, if you want to set the screen display language to “Spanish,” hold down the [KEY] button and turn on the power. When the screen appears, release the button.

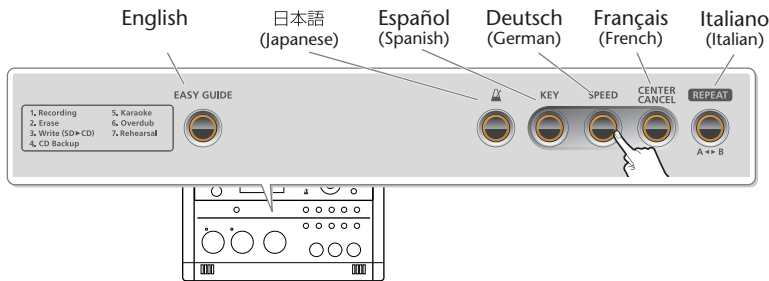

Display language	Button	Screen that appears when you switch power on
English	[EASY GUIDE] button	Language EN English
Japanese	[] (Metronome) button	日本語 JP 日本語
Spanish	[KEY] button	Idioma ES Español
German	[SPEED] button	Sprache DE Deutsch
French	[CENTER CANCEL] button	Langue FR Français
Italian	[REPEAT] button	Lingua IT Italiano

- 3 Turn the power off, then on again.**

After this, the screen display will be in the language you selected in Step 2.

Important

You can also change the display language using the “Language” menu item.



Value	Explanation
EN English (factory setting)	English
JP ニホンゴ	Japanese
ES Español	Spanish
DE Deutsch	German
FR Français	French
IT Italiano	Italian

Returning the Menu Settings to their Factory-Set Condition (Factory Reset)

This operation returns all settings you've made in the menus to their factory-set condition (Factory Reset).

If the CD-2u/SD-2u does not operate as you expect even when you follow the steps in this manual, you may wish to execute the Initialize operation.

1 Press the [MENU] button to access the menu screen, and choose "Factory Reset?"



SYSTEM
Factory Reset? >

① Press the [MENU] button to access the menu screen.

② Use the [<] [>] buttons to choose "Factory Reset?"

③ Press the [ENTER] button to confirm your choice.

2 If you're sure you want to proceed, press the [ENTER] button.

(Note that the process cannot be interrupted once you've started it. If you decide that you don't want to begin the process, press the [EXIT] button.)



Factory Reset
Are You Sure?

The display will show "Processing..," and the factory reset will be executed.

When the factory reset is completed, you're returned to the audio source screen.

Important

For the default value of each setting, refer to "List of Settings" on Page 34.

Formatting an SD Memory Card

If an SD memory card has been used on a computer or other device, and any data remains on that SD memory card, there will be correspondingly less available recording time. By formatting the SD memory card, you can erase all data from the card, ensuring that the full capacity of the card will be available for recording.

Note

- Never turn off the power or disconnect the SD cards or SDHC cards while the screen indicates "Processing..."
- When you format an SD memory card, all data stored on that card will be erased. Content lost in this way cannot be recovered. Please use this operation with caution.

1 Insert the SD memory card that you want to format.

2 Press the [MENU] button to access the menu screen, and choose "Format?"

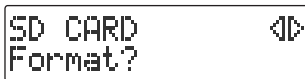

SD CARD
Format? <D>

- ① Press the [MENU] button to access the menu screen.
- ② Use the [<] [>] buttons to choose "Format?"
- ③ Press the [ENTER] button to confirm your choice.

3 If you're sure you want to proceed, press the [ENTER] button.



Format
Are You Sure?

4 If you're still sure you want to proceed, press the [ENTER] button.

(Note that the process cannot be interrupted once you've started it. If you decide that you don't want to begin the process, press the [EXIT] button.)



You'll Lose Data
Really Sure?

The screen will show "Processing..," and the card will be formatted.

When formatting is completed, you're returned to the audio source screen.

Important

You can't format an SD memory card if its write protect switch (Page 26) is in the "LOCK" position.

Adjusting the Left/Right Volume Balance of the Internal Mics

When recording via the internal mics (Page 41), the recorded sound may not be even in volume between the left and right sides, depending on where the CD-2u/SD-2u is located. In such cases, you can adjust the left/right volume balance of the internal mics to compensate for the position in which the CD-2u/SD-2u is placed.

1 Select the internal mics.

- ① Press the [MENU] button to access the menu screen.
- ② Use the [<] [>] buttons to choose "MIC Select."



- ③ Press the [ENTER] button to confirm your choice.
- ④ Use the [+] [-] buttons to change the value to select "Internal."

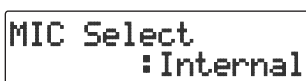

2 Press the [EXIT] button twice.

You'll be returned to the source (audio source) screen.

3 Press the [MENU] button to access the menu screen, and choose "INT MIC Balance."



- ① Press the [MENU] button to access the menu screen.
- ② Use the [<] [>] buttons to choose "INT MIC Balance."
- ③ Press the [ENTER] button to confirm your choice.

4 While producing sound, adjust the left/right volume balance by using the [+] [-] buttons to change the value.

Adjust this setting so that the "L" and "R" level meters move by approximately the same amounts.



Value	Explanation
L50-C (factory setting)-R50	Increasing the "L" value will increase the volume of the input from the left internal mic. With a setting of "L50," no sound will be input from the right internal mic. Conversely, increasing the "R" value will increase the volume of the input from the right internal mic. With a setting of "R50," no sound will be input from the left internal mic. With the "C" (center) setting, the left/right volume balance will be equal.

5 Press the [EXIT] button twice.

You're returned to the audio source screen.

Reversing the Stereo Field of the Internal Mics

When using the internal mics (Page 41), the sound from the mic at the left side of the CD-2u/SD-2u will be recorded on the left channel (L), and the sound from the right mic will be recorded on the right channel (R).

If, as shown in the illustration below, the internal mics are pointed toward the performer on stage, the orientation of the internal mics will be reversed in comparison to the ears of the listeners, causing the recorded sound to be heard with a reversed stereo field.

In such cases, you can exchange the left and right channels of the internal mics. This way, the performance will be recorded just as you heard it.

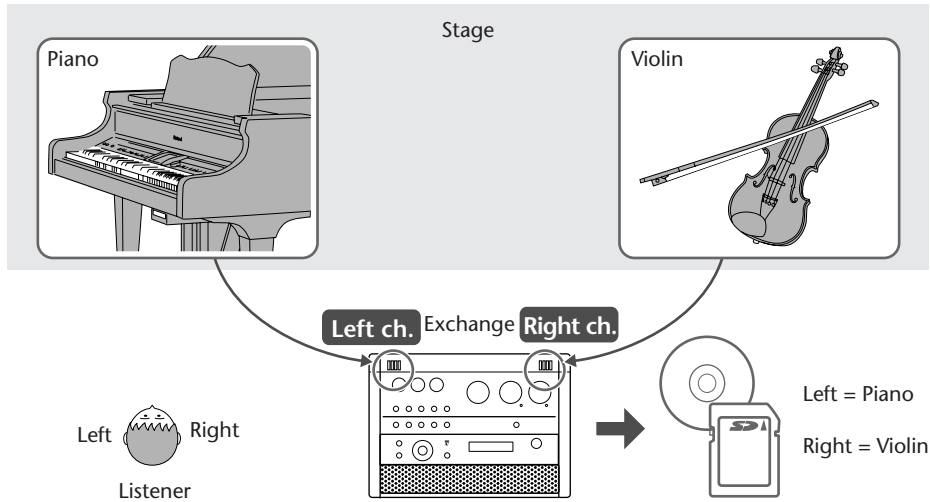

If you're recording your own performance, simply leave the setting as it is.

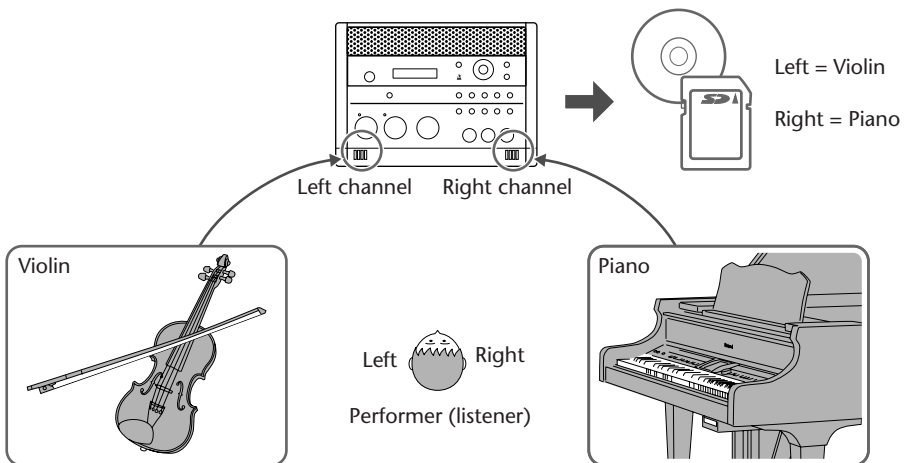

Here's how to exchange the right and left channels of the internal mics.

1 Press the [MENU] button to access the menu screen, and choose "INT MIC Exchange."



- ① Press the [MENU] button to access the menu screen.
- ② Use the [<] [>] buttons to choose "INT MIC Exchange."
- ③ Press the [ENTER] button to confirm your choice.

2 Use the [+] [-] buttons to change the setting, specifying whether you want the left and right channels to be exchanged for the internal mics.

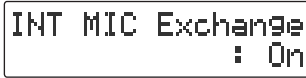

Value	Explanation
On	The left and right channels will be exchanged for the internal mics.
Off (factory setting)	The left and right channels will not be exchanged for the internal mics.

3 Press the [EXIT] button twice.

You're returned to the audio source screen.

Important

- If you have exchanged the left and right channels of the internal mics, the L/R indication of the level meter will be the opposite of the "L" "R" indications.
- If you want to exchange the left and right channels of the recorded song, refer to "Exchanging the Left and Right Audio Channels for Playback" (Page 74).



Connecting External Speakers

You can connect external speakers with built-in amplifier to the LINE OUT jack and use them to listen to playback from the CD-2u/SD-2u or the sound received at its inputs. If you connect the LINE OUT jack to the input jack of your digital piano, you'll be able to listen to the sound using the built-in speakers of your digital piano.

Note

- Once everything is properly connected, be sure to follow the procedure below to turn on their power. If you turn on equipment in the wrong order, you risk causing malfunction or equipment failure.
- To prevent malfunction and equipment failure, always turn down the volume, and turn off all the units before making any connections.

1 Turn off the power of the CD-2u/SD-2u.

- * To prevent acoustic feedback, set the [MIC LEVEL] switch to the "MANUAL" position, and then turn the [MIC] knob all the way to the left so that it's off.

2 Minimize the volume of the external speakers (or digital piano) you'll be connecting, and turn off the power.

3 Connect the CD-2u/SD-2u's left side panel LINE OUT jack to your external speakers (or digital piano).

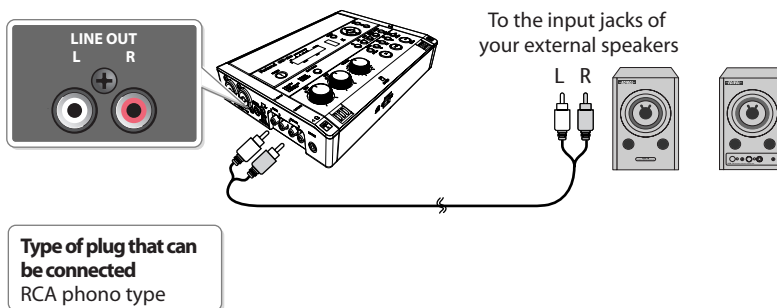

4 Turn on the power of the CD-2u/SD-2u.

5 Turn on the power of your external speakers (or digital piano).

6 Turn the [VOLUME] knob to adjust the output level of the LINE OUT jack. Adjust the volume of your external speakers (or digital piano).

Important

- You can use external speakers that have a built-in amplifier.
- Howling could be produced depending on the location of microphones relative to speakers. This can be remedied by:
 1. Changing the orientation of the microphone(s).
 2. Relocating microphone(s) at a greater distance from speakers.
 3. Lowering volume levels.

Selecting the Audio Source that's Sent from the LINE OUT Jack

You can choose the audio source that is output from the LINE OUT jack.

- 1 Press the [MENU] button to access the menu screen, and choose "OUTPUT Select."



- ① Press the [MENU] button to access the menu screen.
- ② Use the [<] [>] buttons to choose "OUTPUT Select."
- ③ Press the [ENTER] button to confirm your choice.

- 2 Use the [+] [-] buttons to choose the audio source.

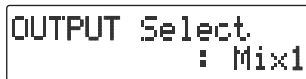

Value	Explanation
Mix1	The audio of all sources is mixed and output.
Mix2	When not recording, all audio sources will be mixed and output. During recording, the audio from the SD memory card (and the audio of the CD CD-2u_{only}) will be output.
MIC	The audio from the EXT MIC (L, R) jacks or the CD-2u/SD-2u's internal mics is output.
LINE	The audio from the LINE IN (L, R) jacks is output.
SD/CD CD-2u_{only} , SD SD-2u_{only} (factory setting)	The audio from the SD memory card or CD is output.

- 3 Press the [EXIT] button twice.
You're returned to the audio source screen.

Troubleshooting

If you suspect a malfunction, please check the following points.
If this does not resolve the problem, contact a nearby Roland distributor.

Power Supply

Problem	Cause and Action	See Page
The power does not turn on when you press the [POWER] button.	<ul style="list-style-type: none">● Could you be using an AC adaptor other than the included one? → Use included dedicated AC adaptor.	22
	<ul style="list-style-type: none">● Could the AC adaptor plug have been disconnected from the CD-2u/SD-2u's AC adaptor jack? Could the power cord have been disconnected from the AC outlet or the dedicated AC adaptor's connector? → Firmly reconnect the dedicated AC adaptor and power cord.	22
	<ul style="list-style-type: none">● Could the remaining battery power be insufficient? → Once the battery runs low, the power may not turn on. Install fresh batteries.	25
	<ul style="list-style-type: none">● Are the batteries installed in the correct orientation? → Check the "⊕" and "⊖" orientation of the batteries, and install them correctly.	24

Screen

Problem	Cause and Action	See Page
The screen is difficult to read	<ul style="list-style-type: none">● Depending on the location or environment in which the CD-2u/SD-2u is placed, the screen may be difficult to read. → Readjust the display contrast.	115
The screen goes dark	<ul style="list-style-type: none">● If you're using batteries, the Backlight Timer setting will dim the screen when you haven't operated the CD-2u/SD-2u for a specified length of time. → Turn the Backlight Timer "Off."	116
Unreadable characters appear on the screen	<ul style="list-style-type: none">● Could you have specified the wrong screen display language? → Select the appropriate screen display language.	117

Problems with the Sound

Problem	Cause and Action	See Page
No sound	<ul style="list-style-type: none"> ● Could the connections be incorrect? → Make the correct connections. 	45, 50, 52
	<ul style="list-style-type: none"> ● Could the power on the connected equipment (mic, digital piano, etc.) be switched off? → Turn on the power. 	—
	<ul style="list-style-type: none"> ● Could the volume of the connected device be turned down? → Raise the volume of the connected device. 	—
	<ul style="list-style-type: none"> ● Could headphones be plugged in? → Unplug the headphones. 	—
	<ul style="list-style-type: none"> ● Is the volume set to the minimum? → Use the [VOLUME] knob to raise the volume. 	70
	<ul style="list-style-type: none"> ● Could the speakers be muted (turned off)? → Press the [Speaker] button so they're turned on. 	74
	<ul style="list-style-type: none"> ● Could the [●] (Record) button be blinking or lit? → In recording-standby mode or while recording, there will be no sound from the speakers. Use headphones if you want to monitor the sound during recording. 	—
The input source (audio source) is not output	<ul style="list-style-type: none"> ● Could the input level be turned down? → If you've connected external mics, turn the [MIC] knob to raise the input level. → If you're inputting audio via the LINE IN (L, R) jacks, turn the [LINE] knob to raise the input level. 	46 50, 52
	<ul style="list-style-type: none"> ● Could MIC SELECT be set to "Internal"? → The sound from the internal mics won't be heard from the speakers. Use headphones if you want to monitor the sound of the internal mics. 	41
	<ul style="list-style-type: none"> ● Could MIC SELECT be set incorrectly? → If you want to record using the internal mics, set to "Internal." → If you want to use external mics for your recording, set to the "External," "Ext(MONO)," or "Plug-In Power." 	41 45
The volume level of the instrument connected to EXT MIC (L, R), LINE IN is too low.	<ul style="list-style-type: none"> ● Could you be using a connection cable that contains a resistor? → Use a connection cable that does not contain a resistor. 	—
	<ul style="list-style-type: none"> ● Could the external mic's sensitivity be set to "Low"? → If the sound from the external mics is still not loud enough even after you've adjusted the input level, set the "EXT MIC Sens" to "High." 	48



Problems with the Sound (continued)

Problem	Cause and Action	See Page
The sound recorded via the internal mics is not loud enough	<ul style="list-style-type: none"> ● Have you adjusted the input level of the internal mics? → Turn the [MIC] knob to raise the input level of the internal mics. 	42
The recorded sound is noisy or distorted	<ul style="list-style-type: none"> ● Is the input level adjusted appropriately? → Noise can tend to be become more noticeable if the sound being input is at a relatively low level. On the other hand, distortion can crop up when the level is high. Try to always keep the input level adjusted to a setting that's appropriately matched to the volume of the sound you're inputting. → If you raise the input level when you're using the external microphones with limited sensitivity, any noise from the internal CD drive could become more noticeable and might be recorded along with your recording. If you feel dissatisfied with the outcome, try using the following procedure when recording. <ol style="list-style-type: none"> ① Use batteries to power the unit. (24) ② Record to SD memory card. (45, 50, 52) ③ Use the AC adaptor to power the unit. (22) ④ Write the song data on the SD memory card to a CD. (95) → Adjust the input level so that the PEAK indicator lights briefly when loud sounds are input. 	42, 46, 50, 52
	<ul style="list-style-type: none"> ● Could the input level be raised for a jack to which no device is connected? → Even if no device is connected, we recommend that you turn down the input level—turn the knob all the way to the left—for everything other than the audio source you're recording. 	—
	<ul style="list-style-type: none"> ● Could MIC SELECT be set to "Internal"? → Even though you thought you were recording using the external mics, a noisy recording may indicate that you were actually recording through the internal mics. If you want to record using the external mics, set to the "External," "Ext(MONO)," or "Plug-In Power." 	45
	<ul style="list-style-type: none"> ● Is the output level set correctly? → If you raise the output level too high, noise or distortion may occur in the sound from the internal speakers. Turn the [OUTPUT LEVEL] knob to adjust the volume. 	70
	<ul style="list-style-type: none"> ● Could you have made bass or treble settings? → Set the bass and treble settings to "0." 	72
An unwanted effect is applied to the sound	<ul style="list-style-type: none"> ● Could you have selected a reverb? → Turn the reverb "Off." 	73
Volume changes are not recorded correctly according to the actual performance	<ul style="list-style-type: none"> ● Could the [MIC LEVEL] switch be set to the "AUTO" position? → The "AUTO" position is suitable for recording human voices at a meeting or lecture, and may be unsuitable for recording an instrumental performance. Change the setting to "MANUAL," and turn the [MIC] knob to adjust the input level. 	44

Checking / Preparations
 Recording
 Listening
 Convenient Functions
 Deleting
 Creating a CD
 Editing an SD
 Information / Display
 Advanced Uses
 Appendices

CD-Related Problems







CD-2U only

Problem	Cause and Action	See Page
Can't insert a CD	<ul style="list-style-type: none"> ● Could you be using batteries? If you're operating the CD-2u/SD-2u on batteries, no CD-related operations can be performed. → Use the dedicated AC adaptor. 	22
Normal playback does not work	<ul style="list-style-type: none"> ● Is the audio source set to "CD"? → Press the [CD] button to choose "CD" as the audio source. 	70
	<ul style="list-style-type: none"> ● Could the CD be upside down? → Insert the CD with the label facing upward. 	29
	<ul style="list-style-type: none"> ● Could you have inserted a CD on which nothing has been recorded? → Insert a different disc. 	—
	<ul style="list-style-type: none"> ● Could you be using repeat playback? → Turn the repeat setting "Off" so that the  or  symbol is not shown. 	79
	<ul style="list-style-type: none"> ● Could you be using A-B Repeat playback? → Press the [REPEAT] button to get the A-B Repeat icon () to disappear. → Alternatively, press the [■] (Stop) button to stop playback. A-B Repeat playback will be defeated. 	80
	<ul style="list-style-type: none"> ● Could the playback speed be turned on? → Turn the Speed setting "off." 	77
	<ul style="list-style-type: none"> ● Could the pitch setting be turned on? → Turn the Pitch setting "off." 	76
	<ul style="list-style-type: none"> ● Could the key setting be turned on? → Turn the key setting "off." 	75
	<ul style="list-style-type: none"> ● Could Center Cancel be turned "On"? → Turn the Center Cancel setting "off." 	78
	<ul style="list-style-type: none"> ● Could the CD be damaged? → Try playing a different CD. 	—
<ul style="list-style-type: none"> ● Could the [▶/] (Play) button be blinking? → If the button is blinking, the CD is paused. Press the [▶/] (Play) button to defeat pause. 	70	
Insufficient playback volume	<ul style="list-style-type: none"> ● Could the CD playback level be turned down? → Use SD/CD Level to raise the playback level. 	55

CD-Related Problems (continued)

Problem	Cause and Action	See Page
Can't record	<ul style="list-style-type: none"> ● Could the CD be upside down? → Insert the CD with the label facing upward. 	29
	<ul style="list-style-type: none"> ● Could you be attempting to record on a CD-R/RW disc that has already been finalized? → Use a blank or un-finalized CD-R/RW disc. → If you want to record on a CD-R/RW disc that has already been finalized, you'll need to remove finalization so that the disc can be recorded to again. 	— 94
	<ul style="list-style-type: none"> ● Is it possible that the maximum recordable time or number of tracks (maximum of 99 tracks) has already been exceeded? → If there are unwanted tracks on the disc, delete them before you continue recording. (This is only possible on a CD-RW disc.) 	92
	<ul style="list-style-type: none"> ● Could you be attempting to record or erase a CD-RW disc more times than it is capable of? → A CD-RW disc can be recorded and erased approximately 1,000 times. 	—
	<ul style="list-style-type: none"> ● Could you be attempting to record an extremely short performance? → You can't record for less than four seconds. 	21
After recording, the CD won't play back on a conventional CD player	<ul style="list-style-type: none"> ● Did you finalize the disc after recording? → Execute the Finalize operation. 	99
	<ul style="list-style-type: none"> ● Is your CD player able to play back CD-R or CD-RW discs? → If your CD player does not support CD-R or CD-RW discs, they may not play back correctly. 	—
The disc tray will not open	<ul style="list-style-type: none"> ● Is the CD-2u/SD-2u powered up? → Turn on the power of the CD-2u/SD-2u. 	22
	<ul style="list-style-type: none"> → If a power failure has occurred, you can use the emergency eject hole to open the disc tray manually. 	30
CD-R/RW drive produces significant mechanical noise when operating	<ul style="list-style-type: none"> ● Could you be using a high-speed compatible CD-RW disc? → If you're using a high-speed compatible CD-RW disc, performing the following operations will cause the disc to rotate at high speed, producing a greater level of mechanical noise. This is not a malfunction. <ul style="list-style-type: none"> • When you stop recording • When you assign a song number • When you delete a track • When you finalize <p>If you find the mechanical operating noise of the CD-R/RW drive objectionable, please use an 8x compatible CD-R disc or a 1-4x compatible CD-RW disc.</p>	—

SD Memory Card-Related Problems

Problem	Cause and Action	See Page
The SD memory card is not detected	<ul style="list-style-type: none"> ● Could the SD memory card be of a capacity that is not supported? → Check the capacity of the SD memory card, and use a card of a capacity supported by the CD-2u/SD-2u. 	20
	<ul style="list-style-type: none"> ● Is the SD memory card inserted all the way into the slot? → Make sure that the card is oriented correctly, and that it's pushed all the way into the slot. 	26
	<ul style="list-style-type: none"> ● Could you have turned off the power while recording, or could the SD memory card have been subjected to a strong impact? → It's possible that the data has been damaged. Reformat the SD memory card. 	119
Normal playback does not work	<ul style="list-style-type: none"> ● Is the mode set to "SD"? <small>CD-2u only</small> → Press the [SD CARD] button to choose "SD" mode. 	70
	<ul style="list-style-type: none"> ● Could you have inserted an SD memory card on which nothing has been recorded? → Insert a different SD memory card. 	—
	<ul style="list-style-type: none"> ● Could you be using repeat playback? → Turn the repeat setting "Off" so that the  or  symbol isn't shown. 	79
	<ul style="list-style-type: none"> ● Could you be using A-B Repeat playback? → Press the [REPEAT] button to get the A-B Repeat icon () to disappear. → Alternatively, press the [] (Stop) button to stop playback. A-B Repeat playback will be defeated. 	80
	<ul style="list-style-type: none"> ● Could the playback speed have been changed? → Set the Speed setting to "Off." 	77
	<ul style="list-style-type: none"> ● Could the Pitch setting have been changed? → Set the Pitch setting to "Off." 	76
	<ul style="list-style-type: none"> ● Could the Key setting have been changed? → Set the Key setting to "Off." 	75
	<ul style="list-style-type: none"> ● Could Center Cancel be turned "On"? → Set the Center Cancel to "Off." ● Could the [/II] (Play) button be blinking? → If the button is blinking, the CD is paused. Press the [/II] (Play) button to defeat pause. 	78 70

SD Memory Card-Related Problems (continued)

Problem	Cause and Action	See Page
Insufficient playback volume	<ul style="list-style-type: none"> ● Could the SD memory card playback level be turned down? → Use SD/CD Level to raise the playback level. 	60
Can't record	<ul style="list-style-type: none"> ● Is the SD memory card inserted all the way into the slot? → Make sure that the card is oriented correctly, and that it's pushed all the way into the slot. 	26
	<ul style="list-style-type: none"> ● Could you be attempting to record an extremely short performance? → You can't record for less than four seconds. 	21
	<ul style="list-style-type: none"> ● Is it possible that the maximum recordable time or number of tracks (maximum of 99 tracks) for the card has been exceeded? → If there are unwanted tracks on the card, delete them before you continue recording. 	86
	<ul style="list-style-type: none"> ● Could the SD memory card be protected? → Slide the protect switch away from the "LOCK" position. 	26

Checking / Preparations

Recording

Listening

Convenient Functions

Deleting

Creating a CD

Editing an SD

Information / Display











Advanced Uses

Appendices

Messages

If a message is displayed, refer to the following list and take the appropriate action.

Messages for which the upper line of the screen shows "-- ERROR!--" will disappear when you press the [ENTER] button.

Message	Content	Action
Battery Low	The batteries are running low.	Install fresh batteries as soon as possible.
Blank Disc 	The CD-R/RW disc is blank (empty).	Use a CD-R/RW disc that isn't blank.
CD Disc Busy 	The disc could not be read/written in time.	Use an unscratched disc. Confirm that the disc can be used (☞ Page 20).
CD Disc Full 	The CD-R/RW disc is full. No more tracks can be recorded.	Record on another CD-R/RW disc. In the case of a CD-RW disc, you can increase the amount of free space by deleting the last song (☞ Page 92).
CD Track Full 	You've reached the maximum number of 99 tracks that can be recorded on a disc. No more tracks can be recorded.	Record on another CD-R/RW disc. In the case of a CD-RW disc, you can increase the amount of free space by deleting the last song (☞ Page 92).
CD Read Failed 	Failed to read a disc.	Use a disc that isn't scratched.
CD Write Failed 	Failed to write a CD-R/RW disc.	Confirm that the disc can be used (☞ Page 20).
Count-in REC	Recording will begin after a count-in.	—
Divide Multiple 	The track will be divided for writing on multiple discs.	—
Finalized Disc 	The disc is an already-finalized CD-R/RW disc or a music CD.	Use an unfinalized CD-R/RW disc.
Improper Disc 	The disc is an inappropriate type for the operation you're attempting to perform.	Use a disc that's appropriate for the operation.
Improper File	This song cannot be edited on the CD-2u/SD-2u.	—
Last SD Track	When joining songs, you selected the last song in the SD memory card. The songs cannot be joined because there's no following song.	Select a song other than the last song, and then execute the join operation.
Locked SD Card	Since the protect switch of the SD memory card is in the LOCK position, songs cannot be recorded or edited.	Slide the protect switch of the SD memory card away from the "LOCK" position.
MICLEVEL is AUTO	If the [MIC LEVEL] switch is set to AUTO, you can't use the [MIC] knob to adjust the input level.	Set the [MIC LEVEL] switch to MANUAL.
No SD Tracks	The SD memory card does not contain any songs to edit or write to the CD.	—
Not A CD-RW 	The disc is not a CD-RW disc.	Use a CD-RW disc.
Not Finalized 	The CD-R/RW disc to be backed up hasn't been finalized.	Please finalize the CD-R/RW disc that you want to back up.
Now Playing..	The operation cannot be performed because playback's in progress.	—
Now Recording	The operation cannot be performed because recording's in progress.	—

Message	Content	Action
Only 1 SD Track	Since there's only one song in the SD memory card, you can't move or join songs.	—
Please Wait	Preparations for playback are being made. Please wait.	—
Power Down	The batteries are depleted. The CD-2u/SD-2u cannot be operated.	Please install fresh batteries.
REC Too Short	You can't stop recording because the elapsed recording time has not reached four seconds. The track number can't be assigned because the location selected is less than four seconds after the previous track number.	Each recording must be longer than four seconds. Assign track numbers at intervals of four seconds or greater.
SD Can't Format	Failed to format the card.	Use a different card.
SD Card Busy	The SD memory card couldn't be read/written in time.	Confirm that the SD memory card can be used (📖 Page 20).
SD Card Full	The card is full. No more tracks can be recorded.	Delete unwanted tracks to increase the free space (📖 Page 86).
SD No Enough Mem	The card doesn't have enough free space for the operation.	Delete unwanted tracks to increase the free space (📖 Page 86).
SD Read Failed	Failed to read an SD memory card.	Turn off the power, and re-insert the SD memory card. Please format the SD memory card (📖 Page 119). Confirm that the SD memory card can be used (📖 Page 20).
SD Track Full	You've reached the maximum number of tracks (99) that can be recorded on an SD memory card. No more tracks can be recorded.	Delete unwanted tracks to increase the free space (📖 Page 86).
SD Was Removed	The SD memory card was removed while reading or writing.	Turn the power off, and then on again; if normal operation doesn't resume, format the card (📖 Page 119).
SD Write Failed	Failed to write an SD memory card.	Confirm that the SD memory card can be used (📖 Page 20). Please format the SD memory card (📖 Page 119).
Short Of Capa <small>CD-2u only</small>	You can't assign an SD track that exceeds the available CD-R/RW disc space.	Either use another CD-R/RW disc, or assign a smaller SD track.
Tr is Too Short	You can't trim in (out) or divide because a track can't be shorter than four seconds.	—
Unknown Disc <small>CD-2u only</small>	The disc cannot be used with the CD-2u/SD-2u.	Confirm that the disc can be used (📖 Page 20).
Unsupported SD	The CD-2u/SD-2u is unable to use this SD memory card.	Use a different card.
Use AC Adaptor <small>CD-2u only</small>	You attempted to perform a CD-related operation without using the dedicated AC adaptor.	Please use the dedicated AC adaptor.
Waiting Signal..	Waiting for audio input to trigger recording.	To begin recording, input an audio signal (📖 Page 63).

Specifications

		CD-2u	SD-2u																																						
Recorder Part	Tracks	2 (Stereo)																																							
	Sampling Rate	44.1 kHz																																							
	Signal Processing	AD/DA conversion: 24 bits																																							
	Recording Mode	SD Memory Card: WAV (44.1 kHz, 16 bits) CD-R, CD-RW: Audio CD	SD Memory Card: WAV (44.1 kHz, 16 bits)																																						
	Recording Media	SD Memory Card (supports 512 MB–16 GB, SDHC format compatible) CD-R, CD-RW	SD Memory Card (supports 512 MB–16 GB, SDHC format compatible)																																						
	Recording Time (unit: min)	<table border="1"> <thead> <tr> <th>CD-R or CD-RW</th> <th>Recording Time</th> </tr> </thead> <tbody> <tr> <td>650 MB</td> <td>74</td> </tr> <tr> <td>700 MB</td> <td>80</td> </tr> </tbody> </table> <table border="1"> <thead> <tr> <th>SD memory card</th> <th>Recording Time</th> </tr> </thead> <tbody> <tr> <td>512 MB</td> <td>47</td> </tr> <tr> <td>1 GB</td> <td>94</td> </tr> <tr> <td>2 GB</td> <td>189</td> </tr> </tbody> </table> <table border="1"> <thead> <tr> <th>SDHC memory card</th> <th>Recording Time</th> </tr> </thead> <tbody> <tr> <td>4 GB</td> <td>377</td> </tr> <tr> <td>8 GB</td> <td>755</td> </tr> <tr> <td>16 GB</td> <td>1511</td> </tr> </tbody> </table>	CD-R or CD-RW	Recording Time	650 MB	74	700 MB	80	SD memory card	Recording Time	512 MB	47	1 GB	94	2 GB	189	SDHC memory card	Recording Time	4 GB	377	8 GB	755	16 GB	1511	<table border="1"> <thead> <tr> <th>SD memory card</th> <th>Recording Time</th> </tr> </thead> <tbody> <tr> <td>512 MB</td> <td>47</td> </tr> <tr> <td>1 GB</td> <td>94</td> </tr> <tr> <td>2 GB</td> <td>189</td> </tr> </tbody> </table> <table border="1"> <thead> <tr> <th>SDHC memory card</th> <th>Recording Time</th> </tr> </thead> <tbody> <tr> <td>4 GB</td> <td>377</td> </tr> <tr> <td>8 GB</td> <td>755</td> </tr> <tr> <td>16 GB</td> <td>1511</td> </tr> </tbody> </table>	SD memory card	Recording Time	512 MB	47	1 GB	94	2 GB	189	SDHC memory card	Recording Time	4 GB	377	8 GB	755	16 GB	1511
	CD-R or CD-RW	Recording Time																																							
650 MB	74																																								
700 MB	80																																								
SD memory card	Recording Time																																								
512 MB	47																																								
1 GB	94																																								
2 GB	189																																								
SDHC memory card	Recording Time																																								
4 GB	377																																								
8 GB	755																																								
16 GB	1511																																								
SD memory card	Recording Time																																								
512 MB	47																																								
1 GB	94																																								
2 GB	189																																								
SDHC memory card	Recording Time																																								
4 GB	377																																								
8 GB	755																																								
16 GB	1511																																								
		<p>* Each recording time is approximate. The times may change depending on the card specifications. * In case that there are plural files, the sum of recording time would be shorter than above. * Maximum recording time of one song is 74 minutes.</p>																																							
	Recording Songs	Up to 99 songs on a single SD memory card, CD-R, or CD-RW	Up to 99 songs on a single SD memory card																																						
Input/Output	Audio Input	Internal Stereo Microphones EXT MIC (L, R) jacks: XLR type (balanced/phantom power DC 48 V, 8 mA Max.), 1/4-inch TRS phone type (balanced/unbalanced) PLUG IN POWER MIC jack: Stereo miniature phone type LINE IN (L, R) jacks: RCA phono type																																							
	Audio Output	Internal Speakers: Stereo LINE OUT (L, R) jacks: RCA phono type PHONES jack: Stereo miniature phone type																																							
	Frequency Response	20 Hz–20 kHz (+0 dB/-2 dB)																																							
	Nominal Input Level (variable)	EXT MIC (L, R) jacks: -51– -8 dBu (common to XLR type and 1/4-inch phone type) PLUG IN POWER MIC jack: -51– -13 dBu LINE IN (L, R) jacks: -24– -4 dBu																																							
	Nominal Output Level	LINE OUT (L, R) jacks: -4 dBu																																							
	Input Impedance	EXT MIC (L, R) jacks: 8 k ohms (common to XLR type and 1/4-inch phone type) PLUG IN POWER MIC jack : 10 k ohms LINE IN (L, R) jacks: 28 k ohms																																							
	Output Impedance	LINE OUT (L, R) jacks: 1 k ohm PHONES jack: 32 ohms																																							
Other	Display	16 characters, two lines (backlit LCD)																																							
	Dimensions	278 (W) x 196 (D) x 55 (H) mm 11 (W) x 7-3/4 (D) x 2-3/16 (H) inches																																							
	Weight (excluding batteries and AC adaptor)	1.4 kg 3 lbs 2 oz																																							
	Power Supply	AC adaptor Alkaline battery (AA, LR6) x 6 Rechargeable Ni-MH battery (HR6) x 6																																							
	Current Draw	1 A	700 mA																																						
	Expected battery life under continuous use	Alkaline battery (AA, LR6): Approx. 5.5 hours Rechargeable Ni-MH battery (AA, HR6): Approx. 6 hours * The time may vary according to usage conditions, batteries used, and type of SD memory card used.																																							
	Accessories	Owner's Manual, Quick Start, Remote controller (with battery CR2025), AC adaptor, Power cord, CD-R disc CD-2u_{only} , SD memory card, SD card protector																																							

* 0 dBu = 0.775 V rms

* In the interest of product improvement, the specifications and/or appearance of this unit are subject to change without prior notice.

Index

A		
Adjusting the readability of the screen	115	
Auto Level	44	
Auto Marker	65, 66	
Auto Marker Lvl	66	
Auto Marker Time	65	
Auto Rec Start	62	
Automatically recording	62	
B		
Backing up	100	
Backlight Timer	116	
Batteries		
Backlight Timer	116	
battery life	25	
remaining indication	25	
Beat (metronome)	82	
Blank disc	21	
C		
Card Info	113	
CD		
Emergency eject hole	30	
Inserting	29	
Removing	30	
writing	95	
CD Erase All?	93	
CD-R/RW disc		
Information	114	
Chromatic tuner	83	
Contrast	115	
Count-in	68	
Count-in (Beat)	68	
D		
Deleting		
a track	86	
all tracks (CD-RW)	93	
all tracks (SD)	87	
region at the beginning of the song (SD) ..	88	
region at the end of the song (SD)	90	
the last track (CD-RW)	92	
Trim In (SD)	88	
Trim Out (SD)	90	
Disc Info	114	
Divide	104	
E		
Easy Guide	37, 38	
Editing an SD memory card		
Divide	104	
Erasing a song	86	
Erasing all songs	87	
formatting	119	
Join	106	
Moving	103	
Normalize	107	
Trim In	88	
Trim Out	90	
Erase Last?	92	
Erase One?	86	
ErasingSee Deleting		
EXT MIC Sens	48, 49	
External mic	45	
Sensitivity	48	
External speakers	123	
F		
Factory Reset	118	
Finalize	30, 99	
removing	94	
Format	27, 119	
G		
Guide tone	85	
I		
Information		
CD-R/RW disc	114	
SD memory card	113	
Input Level		
External mics	46	
Internal mics	42	
LINE IN jacks	50, 52, 56	
Inserting		
CD	29	
SD memory card	26	
INT MIC Balance	120	

INT MIC Exchange	122
Internal mics	
reversing the stereo field	121
volume balance	120

K

Karaoke	54
Key	75

L

Language	117
Limiter	67
LINE IN	50, 52, 56
LINE OUT	123
LINE OUT Select	124

M

Make Backup?	100
Marker	64, 65, 66
Menu	
Factory Reset	118
List of settings	34
Operations	33
Metronome	81
Mic	
External mic	45
Internal mics	41
Moving	103
Muting	74

N

Normalize	107
-----------------	-----

O

Overdub CD->SD?	55
Overdub SD->SD?	60
Overdubbing	59

P

Playback	
changing the key	75
Playback Level	55, 60
Power on/off	
batteries	24
dedicated AC adaptor	22

R

Recording	
Adjusting the input level automatically	44
Maximum recording times	21
Overdubbing	59
Recording a Cassette or MD	52
Recording an electronic instrument	50
Recording karaoke	54
Remaining recording time	112
Using the external mics	45
Using the internal mics	41
Reference pitch	84
Remaining time	112
Remote Control	32
Remote control operation	
disabling	32
operating range	32
Removing	
CD	30
SD memory card	28
Repeat	79
Reset	118
Resume	71
Reverb	73

S

Screen display language	117
SD Erase All?	87
SD memory card	
Information	113
Inserting	26
Removing	28
SD/CD Level	55, 60
Sensitivity (external mic)	48
Settings	
Factory Reset	118
List	34
Song numbers	64, 65, 66
Sound (metronome)	81
Speakers	
connecting	123
muting	74

T

Tempo (metronome)	81
Time indication	112

Track numbers	64, 65, 66
Trim In	88
Trim Out	90
Tuner	83
Tuner/Tone?	83

U

Unfinalize?	94
-------------------	----

V

Viewing information	113, 114
Volume balance	120

W

Write (SD->CD)?	95
Writing (creating a CD)	95

For EU Countries



- UK** This symbol indicates that in EU countries, this product must be collected separately from household waste, as defined in each region. Products bearing this symbol must not be discarded together with household waste.
- DE** Dieses Symbol bedeutet, dass dieses Produkt in EU-Ländern getrennt vom Hausmüll gesammelt werden muss gemäß den regionalen Bestimmungen. Mit diesem Symbol gekennzeichnete Produkte dürfen nicht zusammen mit dem Hausmüll entsorgt werden.
- FR** Ce symbole indique que dans les pays de l'Union européenne, ce produit doit être collecté séparément des ordures ménagères selon les directives en vigueur dans chacun de ces pays. Les produits portant ce symbole ne doivent pas être mis au rebut avec les ordures ménagères.
- IT** Questo simbolo indica che nei paesi della Comunità europea questo prodotto deve essere smaltito separatamente dai normali rifiuti domestici, secondo la legislazione in vigore in ciascun paese. I prodotti che riportano questo simbolo non devono essere smaltiti insieme ai rifiuti domestici. Ai sensi dell'art. 13 del D.Lgs. 25 luglio 2005 n. 151.
- ES** Este símbolo indica que en los países de la Unión Europea este producto debe recogerse aparte de los residuos domésticos, tal como esté regulado en cada zona. Los productos con este símbolo no se deben depositar con los residuos domésticos.
- PT** Este símbolo indica que nos países da UE, a recolha deste produto deverá ser feita separadamente do lixo doméstico, de acordo com os regulamentos de cada região. Os produtos que apresentem este símbolo não deverão ser eliminados juntamente com o lixo doméstico.
- NL** Dit symbool geeft aan dat in landen van de EU dit product gescheiden van huishoudelijk afval moet worden aangeboden, zoals bepaald per gemeente of regio. Producten die van dit symbool zijn voorzien, mogen niet samen met huishoudelijk afval worden verwijderd.
- DK** Dette symbol angiver, at i EU-lande skal dette produkt opsamles adskilt fra husholdningsaffald, som defineret i hver enkelt region. Produkter med dette symbol må ikke smides ud sammen med husholdningsaffald.
- NO** Dette symbolet indikerer at produktet må behandles som spesialavfall i EU-land, iht. til retningslinjer for den enkelte regionen, og ikke kastes sammen med vanlig husholdningsavfall. Produkter som er merket med dette symbolet, må ikke kastes sammen med vanlig husholdningsavfall.

- SE** Symbolen anger att i EU-länder måste den här produkten kasseras separat från hushållsavfall, i enlighet med varje regions bestämmelser. Produkter med den här symbolen får inte kasseras tillsammans med hushållsavfall.
- FI** Tämä merkintä ilmaisee, että tuote on EU-maissa kerättävä erillään kotitalousjätteistä kunkin alueen voimassa olevien määräysten mukaisesti. Tällä merkinnällä varustettuja tuotteita ei saa hävittää kotitalousjätteen mukana.
- HU** Ez a szimbólum azt jelenti, hogy az Európái Unióban ezt a terméket a háztartási hulladékotól elkülönítve, az adott régióban érvényes szabályozás szerint kell gyűjtteni. Az ezzel a szimbólummal ellátott termékeket nem szabad a háztartási hulladék közé dobni.
- PL** Symbol oznacza, że zgodnie z regulacjami w odpowiednim regionie, w krajach UE produktu nie należy wyrzucać z odpadami domowymi. Produktów opatrzonych tym symbolem nie można utylizować razem z odpadami domowymi.
- CZ** Tento symbol udává, že v zemích EU musí být tento výrobek sbírán odděleně od domácího odpadu, jak je určeno pro každý region. Výrobky nesoucí tento symbol se nesmí vyhazovat spolu s domácím odpadem.
- SK** Tento symbol vyjadruje, že v krajinách EÚ sa musí zber tohto produktu vykonávať oddelene od domového odpadu, podľa nariadení platných v konkrétnej krajine. Produkty s týmto symbolom sa nesmú vyhazovať spolu s domovým odpadom.
- EE** See sümbol näitab, et EL-i maades tuleb see toode olemprügist eraldi koguda, nii nagu on igas piirkonnas määratletud. Selle sümboliga märgitud tooteid ei tohi ära visata koos olmeprügiga.
- LT** Šis simbolis rodo, kad ES šalyse šis produktas turi būti surenkamas atskirai nuo buitinių atliekų, kaip nustatyta kiekviename regione. Šiuo simboliu paženklinoti produktai neturi būti išmetami kartu su buitiniems atliekomis.
- LV** Šis simbols norāda, ka ES valstīs šo produktu jāievāc atsevišķi no mājsaimniecības atkritumiem, kā noteikts katrā reģionā. Produktus ar šo simbolu nedrīkst izmest kopā ar mājsaimniecības atkritumiem.
- SI** Ta simbol označuje, da je treba proizvod v državah EU zbirati ločeno od gospodinskih odpadkov, tako kot je določeno v vsaki regiji. Proizvoda tem znakom ni dovoljeno odlagati skupaj z gospodinskimi odpadki.
- GR** Το σύμβολο αυτό υποδηλώνει ότι στις χώρες της Ε.Ε. το συγκεκριμένο προϊόν πρέπει να συλλέγεται χωριστά από τα υπόλοιπα οικιακά απορρίμματα, σύμφωνα με όσα προβλέπονται σε κάθε περιοχή. Τα προϊόντα που φέρουν το συγκεκριμένο σύμβολο δεν πρέπει να απορρίπτονται μαζί με τα οικιακά απορρίμματα.

For China

有关产品中所含有害物质的说明

本资料就本公司产品中所含的特定有害物质及其安全性予以说明。
本资料适用于 2007 年 3 月 1 日以后本公司所制造的产品。

环保使用期限



此标志适用于在中国国内销售的电子信息产品，表示环保使用期限的年数。所谓环保使用期限是指在自制造日起的规定期限内，产品中所含的有害物质不致引起环境污染，不会对人身、财产造成严重的不良影响。
环保使用期限仅在遵照产品使用说明书，正确使用产品的条件下才有效。
不当的使用，将会导致有害物质泄漏的危险。

产品中有毒有害物质或元素的名称及含量

部件名称	有毒有害物质或元素					
	铅(Pb)	汞(Hg)	镉(Cd)	六价铬(Cr(VI))	多溴联苯(PBB)	多溴二苯醚(PBDE)
外壳(壳体)	×	○	○	○	○	○
电子部件(印刷电路板等)	×	○	×	○	○	○
附件(电源线、交流适配器等)	×	○	○	○	○	○

○：表示该有毒有害物质在该部件所有均质材料中的含量均在 SJ/T11363-2006 标准规定的限量要求以下。
×：表示该有毒有害物质至少在该部件的某一均质材料中的含量超出 SJ/T11363-2006 标准规定的限量要求。
因根据现有的技术水平，还没有什么物质能够代替它。

For EU Countries

Apparatus containing Lithium batteries

ADVARSEL!

Lithiumbatteri - Eksplosionsfare ved fejlagtig håndtering.
Udskiftning må kun ske med batteri af samme fabrikat og type.
Levér det brugte batteri tilbage til leverandøren.

ADVARSEL

Eksplosjonsfare ved feilaktig skifte av batteri.
Benytt samme batteritype eller en tilsvarende type anbefalt av apparatfabrikanten.
Brukte batterier kasseres i henhold til fabrikantens instruksjoner.

CAUTION

Danger of explosion if battery is incorrectly replaced.
Replace only with the same or equivalent type recommended by the manufacturer.
Discard used batteries according to the manufacturer's instructions.

VARNING

Explosionsfara vid felaktigt batteribyte.
Använd samma batterityp eller en ekvivalent typ som rekommenderas av apparattillverkaren.
Kassera använt batteri enligt fabrikantens instruktion.

VAROITUS

Paristo voi räjähtää, jos se on virheellisesti asennettu.
Vaihda paristo ainoastaan laitevalmistajan suosittelemaan tyyppiin. Hävitä käytetty paristo valmistajan ohjeiden mukaisesti.

For EU Countries



This product complies with the requirements of EMC Directive 2004/108/EC.

For the USA

FEDERAL COMMUNICATIONS COMMISSION RADIO FREQUENCY INTERFERENCE STATEMENT

This equipment has been tested and found to comply with the limits for a Class B digital device, pursuant to Part 15 of the FCC Rules. These limits are designed to provide reasonable protection against harmful interference in a residential installation. This equipment generates, uses, and can radiate radio frequency energy and, if not installed and used in accordance with the instructions, may cause harmful interference to radio communications. However, there is no guarantee that interference will not occur in a particular installation. If this equipment does cause harmful interference to radio or television reception, which can be determined by turning the equipment off and on, the user is encouraged to try to correct the interference by one or more of the following measures:

- Reorient or relocate the receiving antenna.
- Increase the separation between the equipment and receiver.
- Connect the equipment into an outlet on a circuit different from that to which the receiver is connected.
- Consult the dealer or an experienced radio/TV technician for help.

This device complies with Part 15 of the FCC Rules. Operation is subject to the following two conditions:

- (1) this device may not cause harmful interference, and
- (2) this device must accept any interference received, including interference that may cause undesired operation.

Unauthorized changes or modification to this system can void the users authority to operate this equipment.
This equipment requires shielded interface cables in order to meet FCC class B Limit.

For Canada

NOTICE

This Class B digital apparatus meets all requirements of the Canadian Interference-Causing Equipment Regulations.

AVIS

Cet appareil numérique de la classe B respecte toutes les exigences du Règlement sur le matériel brouilleur du Canada.

For C.A. US (Proposition 65)

WARNING

This product contains chemicals known to cause cancer, birth defects and other reproductive harm, including lead.

